

AMERICAN ACADEMY OF PEDIATRICS

Developmental Dysplasia of the Hip Practice Guideline: Technical Report

Harold P. Lehmann, MD, PhD*; Richard Hinton, MD, MPH*; Paola Morello, MD*; and Jeanne Santoli, MD*
in conjunction with the Committee on Quality Improvement, Subcommittee on
Developmental Dysplasia of the Hip

ABSTRACT. *Objective.* To create a recommendation for pediatricians and other primary care providers about their role as screeners for detecting developmental dysplasia of the hip (DDH) in children.

Patients. Theoretical cohorts of newborns.

Method. Model-based approach using decision analysis as the foundation. Components of the approach include the following:

Perspective: Primary care provider.

Outcomes: DDH, avascular necrosis of the hip (AVN).

Options: Newborn screening by pediatric examination; orthopaedic examination; ultrasonographic examination; orthopaedic or ultrasonographic examination by risk factors. Intercurrent health supervision-based screening.

Preferences: 0 for bad outcomes, 1 for best outcomes.

Model: Influence diagram assessed by the Subcommittee and by the methodology team, with critical feedback from the Subcommittee.

Evidence Sources: Medline and EMBASE search of the research literature through June 1996. Hand search of sentinel journals from June 1996 through March 1997. Ancestor search of accepted articles.

Evidence Quality: Assessed on a custom subjective scale, based primarily on the fit of the evidence to the decision model.

Results. After discussion, explicit modeling, and critique, an influence diagram of 31 nodes was created. The computer-based and the hand literature searches found 534 articles, 101 of which were reviewed by 2 or more readers. Ancestor searches of these yielded a further 17 articles for evidence abstraction. Articles came from around the globe, although primarily Europe, British Isles, Scandinavia, and their descendants. There were 5 controlled trials, each with a sample size less than 40. The remainder were case series. Evidence was available for 17 of the desired 30 probabilities. Evidence quality ranged primarily between one third and two thirds of the maximum attainable score (median: 10–21; interquartile range: 8–14).

Based on the raw evidence and Bayesian hierarchical meta-analyses, our estimate for the incidence of DDH revealed by physical examination performed by pediatricians is 8.6 per 1000; for orthopaedic screening, 11.5; for ultrasonography, 25. The odds ratio for DDH, given breech delivery, is 5.5; for female sex, 4.1; for positive family history, 1.7, although this last factor is not statistically significant. Postneonatal cases of DDH were di-

vided into mid-term (younger than 6 months of age) and late-term (older than 6 months of age). Our estimates for the mid-term rate for screening by pediatricians is 0.34/1000 children screened; for orthopaedists, 0.1; and for ultrasonography, 0.28. Our estimates for late-term DDH rates are 0.21/1000 newborns screened by pediatricians; 0.08, by orthopaedists; and 0.2 for ultrasonography. The rates of AVN for children referred before 6 months of age is estimated at 2.5/1000 infants referred. For those referred after 6 months of age, our estimate is 109/1000 referred infants.

The decision model (reduced, based on available evidence) suggests that orthopaedic screening is optimal, but because orthopaedists in the published studies and in practice would differ, the supply of orthopaedists is relatively limited, and the difference between orthopaedists and pediatricians is statistically insignificant, we conclude that pediatric screening is to be recommended. The place of ultrasonography in the screening process remains to be defined because there are too few data about postneonatal diagnosis by ultrasonographic screening to permit definitive recommendations. These data could be used by others to refine the conclusions based on costs, parental preferences, or physician style. Areas for research are well defined by our model-based approach. *Pediatrics* 2000;105(4). URL: <http://www.pediatrics.org/cgi/content/full/105/4/e57>; *developmental dysplasia of the hip, avascular necrosis of the hip, newborn*.

ABBREVIATIONS. DDH, developmental dysplasia of the hip; PE, physical examination; AVN, avascular necrosis of the hip; SD, standard deviation.

I. GUIDELINE METHODS

A. Decision Model

The steps required to build the model were taken with the Subcommittee as a whole, with individuals in the group, and with members of the methodology team. Agreement on the model was sought from the Subcommittee as a whole during face-to-face meetings.

1. Perspective

Although there are a number of perspectives to take in this problem (parental, child's, societal, and payer's), we opted for the view of the practicing clinician: What are the clinician's obligations, and what is the best strategy for the clinician? This choice

From *Johns Hopkins University, Baltimore, Maryland.

The recommendations in this statement do not indicate an exclusive course of treatment or serve as a standard of medical care. Variations, taking into account individual circumstances, may be appropriate.

PEDIATRICS (ISSN 0031 4005). Copyright © 2000 by the American Academy of Pediatrics.

TABLE 1. Outcome Definitions

Outcome	Language From an Article That Was Considered a Result That Was. . .		
	Positive	Intermediate	Negative
Nonorthopaedist PE	Dislocated, dislocatable, luxated, luxatable, Ortolani positive, Barlow positive, clunk, unstable, neonatal hip instability	Click, lax	Normal, reduced, located
Ultrasonography results	Dynamic examination: dislocated, dislocatable, luxated, luxatable; static examination: Graf IIc, IId, III, IV	Dynamic examination: subluxed, subluxable, dysplastic; static examination: Graf IIb	Normal, reduced, located
Orthopaedist action	Pavlik harness, von Rosen harness, Frejka pillow, surgery	Multiple diapers, abduction splint	Occasional follow-up

of perspective meant that the focus would be on screening for developmental dysplasia of the hip (DDH) and obviated the need to review the evidence for efficacy or effectiveness of specific strategies.

2. Context

The target child is a full-term newborn with no obvious orthopaedic abnormalities. Children with such findings would be referred to an orthopaedist, obviating the need for a practice parameter.

3. Options

We focused on the following options: screening by physical examination (PE) at birth by a pediatrician, orthopaedist, or other care provider; ultrasonographic screening at birth; and episodic screening during health supervision. Treatment options are not included.

We also included in our model a wide range of options for managing the screening process during the first year of life when the newborn screening was negative.

4. Outcomes

Our focus is on dislocated hips at 1 year of age as the major morbidity of the disease and on avascular necrosis of the hip (AVN), as the primary sentinel complication of DDH therapy.

Ideally, we would have a “gold standard” that would define DDH at any point in time, much as cardiac output can be obtained from a pulmonary-artery catheter. However, no gold standard exists. Therefore, we defined our outcomes in terms of the process of care: a pediatrician and an ultrasonographer perform initial or confirmatory examinations and refer the patient, whereas the orthopaedist treats the patient. It is the treatment that has the greatest effect on postneonatal DDH or on complications, so we focus on that intermediate outcome, rather than the orthopaedist’s stated diagnosis.

We operationalized the definitions of these outcomes for use in abstracting the data from articles. Table 1 presents our definitions. A statement that a “click” was found on PE was considered to refer to an intermediate result, unless the authors defined their “click” in terms of our definition of a positive examination. *Dynamic* ultrasonographic examinations include those of Harcke et al,¹ and *static* refers primarily to that of Graf.² The radiologic focus switches from ultrasonography to plain radiographs

after 4 months of age, in keeping with the development of the femoral head.

5. Decision Structure

We used an influence diagram³⁻⁵ to represent the decision model. In this representation, nodes refer to actions to be taken (rectangles) or to states of the world (the patient) about which we are uncertain (ovals). We devoted substantial effort to the construction of a model that balanced the need to represent the rich array of possible screening pathways with the need to be parsimonious. We constructed the master influence diagram (Fig 1) and determined its construct validity through consensus by the Subcommittee before data abstraction. However, the available evidence could specify only a portion of the diagram. The missing components suggest research questions that need to be posed. Figure 2 depicts the master influence diagram. Table 2 gives the node definitions.

6. Probabilities

The purpose of the literature review was to provide the probabilities required by the decision model. The initial list of required probabilities is given in Table 2. The initial number of individual probabilities was 55. (Sensitivity and specificity for a single truth-indicator pair are counted as a single probability because they are garnered from the same table.)

Although this is a large number of parameters, the structure of the model helped the team of readers. As 1 reader said, referring to the influence diagram, “Because we did the picture together, it was easy to find the parameters.”

What follows are some operational rules for matching the data to our parameters. The list is not complete.

If an orthopaedic clinic worked at case finding, we used our judgment to determine whether to accept such reports as representing a population incidence (eg, target article 1).*

Risk factors were included generally only if a true control group was used for comparison (eg, not in target article 1).

For postneonatal diagnoses, no study we reviewed included the examination of all children without DDH, say, 1 year of age, so there is always the possibility of missed cases (false-negative diagnoses) in the screen, which leads to a falsely elevated esti-

*Target articles are those used for the literature review; they are listed separately following the reference list.

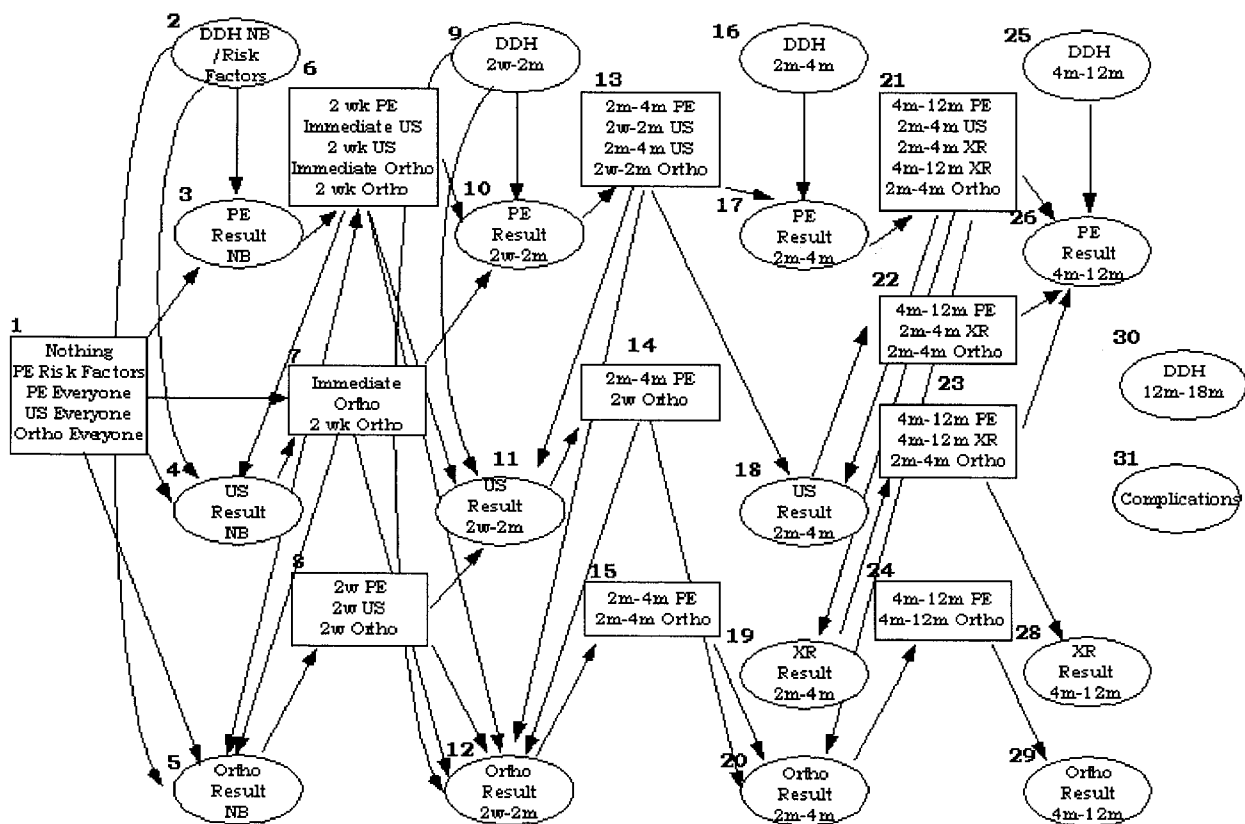

Fig 1. Influence diagram as constructed before evidence synthesis. Nodes 30 and 31 have no arrows impinging because all nodes have arrows going into those nodes, expressing all the possibilities of postneonatal DDH.

mate of the denominator (eg, target article 2). For studies originating in referral clinics, the data on the reasons for referrals were not usable for our purposes (eg, target article 3).

7. Preferences

Ideally, we would have cost data for the options, as well as patient data on the human burden of therapy and of DDH itself. We have deferred these assessments to later research. Therefore, we assigned a preference score of 0 to DDH at 1 year of age and 1 to its absence; for AVN, we assigned 0 for presence at 1 year of age and 1 for absence at 1 year of age.

B. Literature Review

For the literature through May 1995, the following sources were searched: Books in Print, CATLINE, Current Contents, EMBASE, Federal Research in Progress, Health Care Standards, Health Devices Alerts, Health Planning and Administration, Health Services/Technology Assessment, International Health Technology Assessment, and Medline. Medline and EMBASE were searched through June 1996. The search terms used in all databases included the following: hip dislocation, congenital; hip dysplasia; congenital hip dislocation; developmental dysplasia; ultrasonography/adverse effects; and osteonecrosis. Hand searches of leading orthopaedic journals were performed for the issues from June 1996 to March 1997. The bibliographies of journals accepted for use in formulating the practice parameter also were perused.

The titles and the abstracts were then reviewed by 2 members of the methodology team to determine whether to accept or reject the articles for use. Decisions were reviewed by the Subcommittee, and conflicts were adjudicated. Similarly, articles were read by pairs of reviewers; conflicts were resolved in discussion.

The focus of the data abstraction process was on data that would provide evidence for the probabilities required by the decision model.

As part of the literature abstraction process, the evidence quality in each article was assessed. The scoring process (Table 3) was based on our decision model and involved traditional epidemiologic concerns, like outcome definition and bias of ascertainment, as well as influence-diagram-based concerns, such as how well the data fit into the model.

Cohort definition: Does the cohort represented by the denominator in the study match a node in our influence diagram? Does the cohort represented by the numerator match a node in our influence diagram? The closer the match, the more confident we are that the reported data provide good evidence of the conditional probability implied by the arrow between the corresponding nodes in the influence diagram.

Path: Does the implied path from denominator to numerator lead through 1 or more nodes of the influence diagram? The longer the path, the more likely that uncontrolled biases entered into the study,

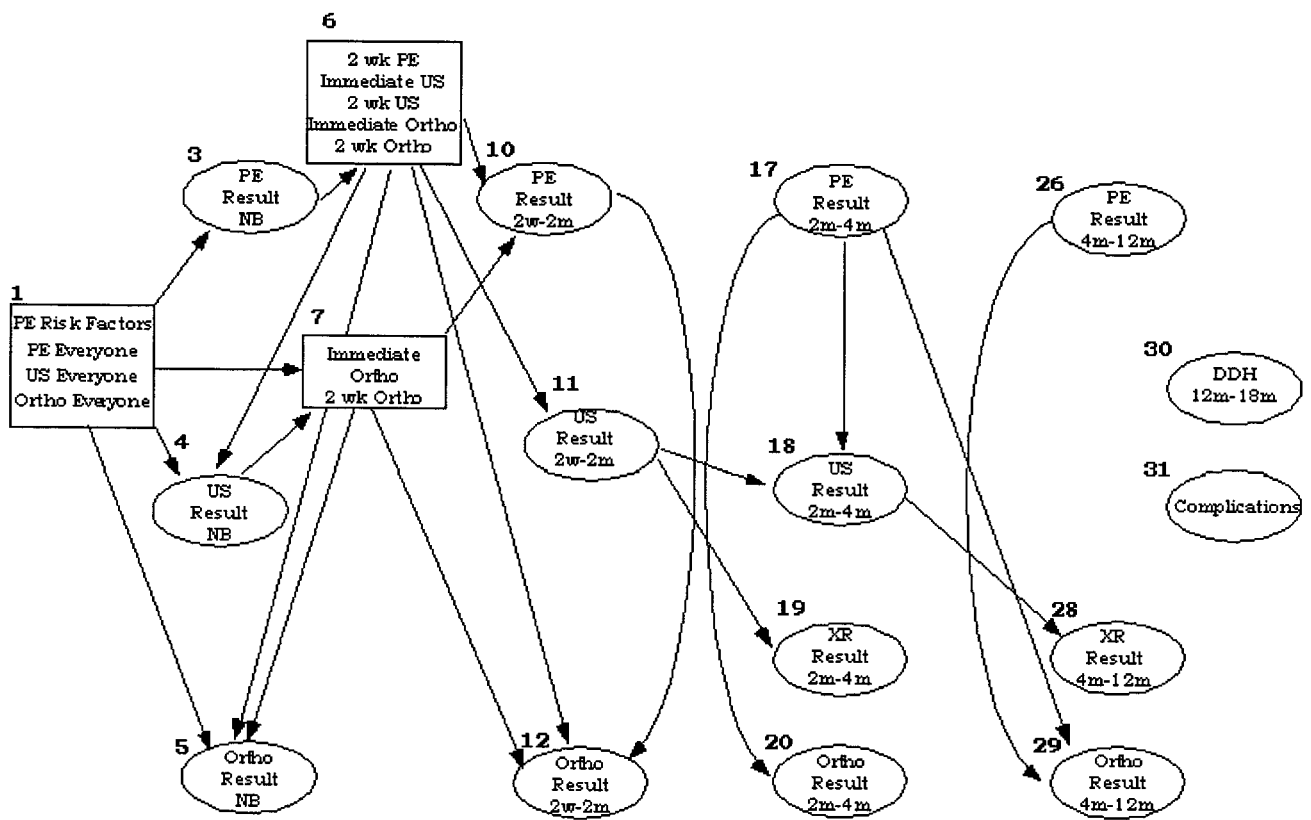

Fig 2. Influence diagram with nodes and arcs for which data were obtained.

making us less confident about accepting the raw data as a conditional probability in our model.

Assignment and comparison: Was there a control group? How was assignment made to experimental or control arms? A randomized, controlled study provides the best quality evidence.

Follow-up: Were patients with positive and negative initial findings followed up? The best studies should have data on both.

Outcome definition: Did the language of the outcome definitions (PE, orthopaedic examination, ultrasonography, and radiography) match ours, and, in particular, were PE findings divided into 3 categories or 2? The closer the definition to ours, the more we could pool the data. Studies with only 2 categories do not help to distinguish clicks from “clunks.”

Ascertainment: When the denominator represented more than 1 node, to what degree was the denominator a mix of nodes? The smaller the contamination, the more confident we were that the raw data represented a desired conditional probability.

Results: Did the results fill an entire table or were data missing? This is related to the follow-up category but is more general.

C. Synthesis of Evidence

There are 3 levels of evidence synthesis.

1. Listing evidence for individual probabilities
2. Summarizing evidence across probabilities
3. Integrating the pooled evidence for individual probabilities into the decision model

A list of evidence for an individual probability (or arc) is called an *evidence table* and provides the reader a look at the individual pieces of data.

The probabilities are summarized in 3 ways: by averaging, by averaging weighted by sample size (pooled), and by meta-analysis. We chose Bayesian meta-analytic techniques,⁶ which allow the representation of *prior belief* in the evidence and provide an explicit portrayal of the uncertainty of our conclusions. The framework we used was that of a hierarchical Bayesian model,⁷ similar to the random effects model in traditional meta-analysis.⁸ In this hierarchical model (Fig 3), each study has its own parameter, which, in turn, is sampled from a wider population parameter. Because there are 2 stages (ie, population to sample and sample to observation), and, therefore, the population parameter of interest is more distant from the data, the computed estimates in the population parameters are, in general, less certain (wider confidence interval) than simply pooling the data across studies. This lower certainty is appropriate in the DDH content area because the studies vary so widely in their raw estimates because of the range in time and geography over which they were performed.

In the Bayesian model, the observations were assumed to be Poisson distributed, given the study DDH rates. Those rates, in turn, were assumed to be Gamma distributed, given the population rate. The prior belief on that rate was set as Gamma (α , β), with mean α/β , and variance α/β^2 (as defined in the BUGS software⁹). In this parameterization, α has the semantics closest to that of location, and β has the

TABLE 2. Node Definitions*

Number	Node Name†	Values	Definition
1	<i>NB options</i>	Nothing, PE, US, orthopaedic examination of at-risk infant	Options available at birth to the PCP
2	DDH in NB	Present, absent	True prevalence of DDH at birth
3	PE result in NB	Positive, negative	Result of PCP's PE at NB
4	US result in NB	Positive, negative	Result of US ordered by PCP at NB
5	Orthopaedic evaluation in NB	Positive, negative	Result of orthopaedic evaluation of NB
6	<i>Post-NB PE options</i>	PE 2 wk; immediate US; US 2 wk; immediate orthopaedic examination; orthopaedic examination 2 wk	Options after NB PE
7	<i>Post-NB US options</i>	Immediate orthopaedic examination; delayed orthopaedic examination	Options after NB US
8	<i>Post-NB orthopaedic evaluation options</i>	PE 2 wk; US 2 wk; orthopaedic evaluation 2 wk	Options after NB orthopaedic evaluation
9	<i>DDH at 2 wk</i>	Present, absent	True prevalence of DDH at 2 wk
10	<i>PE result at 2 wk</i>	Positive, negative	Result of PCP's PE at 2 wk
11	US result at 2 wk	Positive, negative	Result of US ordered by PCP at 2 wk
12	Orthopaedic evaluation at 2 wk	Positive, negative	Result of orthopaedic evaluation at 2 wk
13	<i>Options after PE at 2 wk PE</i>	PE <4 mo; immediate US; delayed US; immediate orthopaedic examination	Options after 2-wk PE
14	<i>Options after US 2 wk</i>	Orthopaedic examination 2 wk; PE <4 mo	Options after NB US
15	<i>Options after orthopaedic examination 2 wk</i>	PE <4 mo; orthopaedic examination <4 mo	Options after 2-wk orthopaedic evaluation
16	<i>DDH <4 mo</i>	Present, absent	True prevalence of DDH <4 mo (and after 2 wk)
17	<i>PE result <4 mo</i>	Positive, negative	Result of PCP's PE <4 mo
18	<i>US result <4 mo</i>	Positive, negative	Result of US ordered by PCP <4 mo
19	<i>Radiography result <4 mo</i>	Positive, negative	Result of radiography (anteroposterior, "frog" position) <4 mo
20	Orthopaedic evaluation <4 mo	Positive, negative	Result of orthopaedic evaluation <4 mo
21	<i>Options after PE <4 mo</i>	PE <12 mo; immediate US; immediate radiographs; delayed radiographs; immediate orthopaedic evaluation	Options after PE <4 mo
22	<i>Options after US <4 mo</i>	PE <12 mo; delayed radiographs; immediate orthopaedic evaluation	Options after US <4 mo
23	<i>Options after radiography <4 mo</i>	PE <12 mo; delayed radiographs; immediate orthopaedic evaluation	Options after radiography <4 mo
24	<i>Options after orthopaedic evaluation 4 mo</i>	PE <12 mo; orthopaedic evaluation <12 mo	Options after orthopaedic evaluation <4 mo
25	<i>DDH <12 mo</i>	Present, absent	True prevalence of DDH <12 mo (and after 4 mo)
26	<i>PE result <12 mo</i>	Positive, negative	Result of PCP's PE <12 mo
28	<i>Radiography result <12 mo</i>	Positive, negative	Result of radiograph between 4 and 12 mo
29	Orthopaedic evaluation <12 mo	Positive, negative	Result of orthopaedic evaluation <12 mo
30	DDH <18 mo	Present, absent	True prevalence of DDH >12 mo
31	Complications of treatment	AVN present; AVN absent	Late complications of treatment for DDH

* NB indicates newborn; PCP, primary care provider; US, ultrasonography.

† Bold type indicates nodes for which the articles provided substantive evidence; italic type indicates unobservables (true DDH at any time epoch) or decision node; plain type indicates chance node with little evidence.

semantics of certainty: the higher its value, the narrower the distribution and the more certain we are of the estimate. The parameter, α , was modeled as Exponential (1), and β , as Gamma (0.01, 1), with a mean of 0.01. Together, these correspond to a prior belief in the rate of a mean of 100 per 1000, and a standard deviation (SD) of 100, representing ignorance of the true rate.

As an example of interpretation, for pediatric newborn screening, the posterior α was 1.46, and the posterior β was 0.17, to give a posterior rate of 8.6/1000, with a variance of 50, or an SD of 7.1. Note that the value of β rose from 0.01 to 0.17, indicating a higher level of certainty (Fig 4; Table 4).

The Bayesian confidence interval is the narrow-

est interval that contains 95% of the area under the posterior-belief curve.¹⁰ The confidence interval for the prior curve is 2.53 to 370. The confidence interval for the posterior curve is 0.25 to 27.5, a significant shrinking and increase in certainty but still broad.

The model for the odds ratios is more complicated and is based on the Oxford data set and analysis in the BUGS manual.⁹

D. Thresholds

In the course of discussions about results, the Subcommittee was surveyed about the acceptable risks of DDH for different levels of interventions.

TABLE 3. DDH Evidence Quality Inventory

Concern	Points			
	3	2	1	0
Cohort definition	Both match our nodes	One matches, the other is close	Neither match, but both close	Mix or unclear
Path	Short path	1 node intermediate	>1 node intermediate	Unclear path
Assignment and comparison	Random	Comparative arm	Single arm	Haphazard
Follow up	Positives and negatives	All positives	...	Some positives
Outcome definition	Matches ours	3 (all) categories	2 categories	No explicit definition
Ascertainment	No contamination	Contamination <10%	Contamination ≤20%	Contamination >20%
Results	Fill entire table	Fill partial table	Fill entire row or column	Fill partial row or column

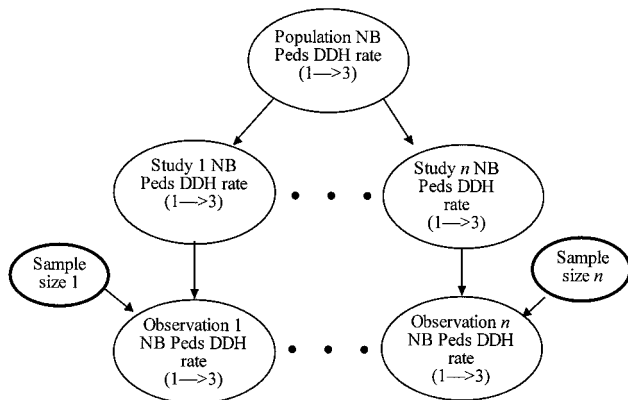

Fig 3. Model of hierarchical Bayesian meta-analysis. This example is for the probability of positive DDH examination results performed by pediatricians in the newborn period, denoted as $1 \rightarrow 3$ in the influence diagram.

E. Recommendations

Once the evidence and thresholds were obtained, a decision tree was created from the evidence available and was reviewed by the Subcommittee. In parallel, a consensus guideline (flowchart) was created. The Subcommittee evaluated whether evidence was available for links within the guidelines, as well as their strength of consensus. The decision tree was evaluated to check consistency of the evidence with the conclusions.

F. “Cost”-Effectiveness Ratios

To integrate the results, we defined cost-effectiveness ratios, in which *cost* was excess neonatal referrals or excess cases of AVNs, and *effectiveness* was a decrease in the number of later cases. The decision tree from section E (“Recommendations”) was used to calculate the expected outcomes for each of pediatric, orthopaedic, and ultrasonographic strategies. Pediatric strategy was used as the baseline, because its neonatal screening rate was the lowest. The cost-effectiveness ratios then were calculated as the quotient of the difference in cost and the difference in effect.

RESULTS

A. Articles

Figure 5 shows the article-winning process. The distribution over publication years is shown in Fig 6.

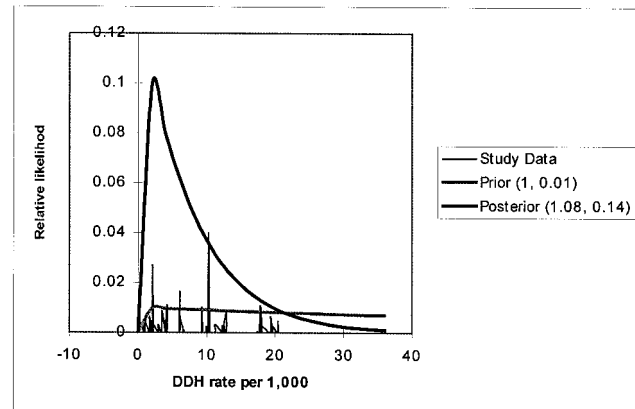

Fig 4. Prior, data, and posterior curves for pediatric screening. The prior is broad and flat, suggesting minimal prior knowledge, whereas the posterior curve is peaked and narrowed to the left, where the posterior estimate of 7.7 lies. The data are represented as mean rate (x-axis) and square-root of the sample size (y-axis), to give a sense of the “weight” of the data.

The peak number of articles is for 1992, with 10 articles. The articles are from sites all over the world, although the Nordic, Anglo-Saxon, and European communities and their descendants are the most represented (Fig 7).

B. Evidence

By traditional epidemiologic standards, the quality of evidence in this set of articles is uniformly low. There are few controlled trials and few studies in which infants with negative results on their newborn examinations are followed up. (A number of studies attempted to cover all possible places where an affected child might have been ascertained.)

We found data on all chance nodes, for a total of 298 distinct tables. *Decision* nodes were poorly represented: beyond the neonatal strategy, there were almost no data clarifying the paths for the diagnosis children after the newborn period. Thus, although communities like those in southeast Norway have a postnewborn screening program, it is unclear what the program was, and it was unclear how many examination results were normal before a child was referred to an orthopaedist (eg, target articles 4 and 5).

The distribution of evidence qualities is shown in Fig 8. The mode is a score of 10, achieved in 16

TABLE 4. Summary of Evidence Tables for Newborn Screening Strategies*

Strategy (Arc†)	Positive Screen Rate per 1000 Examinations			Sample Size Average (SD)	Sample Size Total	No. of Arms§
	Unweighted Average (SD)	Weighted Average‡ (SD)	Meta-analytic Average (SD)			
Pediatric examination (1 → 3)	8.7 (6.4)	8 (4)	8.6 (7.1)	61 941¶ (170 647)	2 044 057	54
Orthopaedic examination (1 → 5)	22 (60)	7 (3.7)	22 (28)	26 342# (40 923)	740 600	28
Ultrasonographic examination (1 → 4)	11.5** (11)		11.4** (11)			
	37.7 (55)	25.4 (32)	36 (39)	2636 (2171)	44 808	17
	26†† (27)	22†† (17)	24.9†† (23.5)			

* See Evidence Tables 1, 2, and 3.

† Arc refers to the influence diagram (see Fig. 2).

‡ Weighted estimates computed by pooling the numerators and denominators of the target arms.

§ Some studies involved more than 1 arm.

|| Only studies acknowledging 3 categories were included.

¶ Without outliers (target article 21 [917 865 subjects] and target article 23 [415 542 subjects]), the mean (SD) is 22 924 (30 015).

Excluding outliers (target article 43 [202 657 subjects] and target article 40 [108 966 subjects]), the mean (SD) is 16 499 (11 170).

** Excluding an outlier (target article 104, with a rate of 325.3/1000).

†† Without the outlier, target article 69 (224/1000).

articles. The median is 9.9, with an interquartile range of 8 to 14, suggesting that articles with scores below 8 are poor sources of evidence. Note that the maximum achievable quality score is 21, so half the articles do not achieve half the maximum quality score.

Graphing evidence quality against publication year suggests an improvement in quality over time, as shown in Fig 9, but the linear fit through the data is statistically indistinguishable from a flat line. (A nonparametric procedure yields the same conclusion).

The studies include 5 in which a comparative arm was designed into the study. The remainder are divided between prospective and retrospective studies. Surprisingly, the evidence quality is not higher in the former than in the latter (data not shown).

Of the 298 data tables, half the data tables relate to the following:

- probabilities of DDH in different screening strategies
- relative risk of DDH, given risk factors
- the incidence of postneonatal DDH, and
- the incidence of AVN.

The remainder of our discussion will focus on these probabilities.

C. Evidence Tables

The evidence table details are found in the “Appendix.”

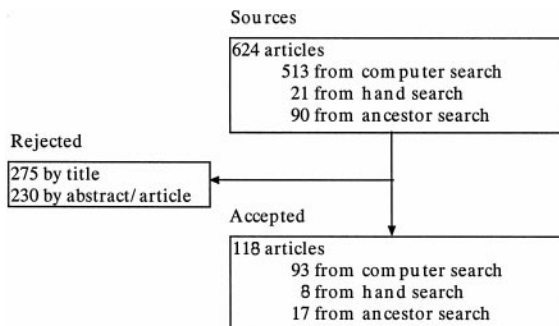

Fig 5. Process of article choice.

1. Newborn Screening

a. Pediatric Screening

There were 51 studies, providing 57 arms, for pediatric screening. However, of these, 17 were unclear on how the intermediate examinations were handled, and, unsurprisingly, their observed rates of positivity (clicks) were much higher than the studies that distinguished 3 categories, as we had specified. Therefore, we included only the 34 studies (target articles 3, 6–37) that used 3 categories.

For pediatric screening, the rate is about 8 positive cases per 1000 examinations. Fig 10 shows the distribution of the observed rates. The rates are distributed almost uniformly between 0 and 20 per 1000.

Figure 11 shows the distribution of the sample sizes for these studies; 3 outlier studies were excluded to avoid compression of the histogram. All studies represent a large experience: a total of 2 149 972 subjects. Although their methods may not have been the best, the studies demand attention simply because of their size.

In looking for covariates or confounding variables, we studied the relationship between positivity rate and the independent variables, year of publication (Fig 12), evidence quality, and sample size. Year and evidence quality show a positive effect: the higher the year (slope: 0.2; $P = .018$) or evidence quality (slope: 0.6; $P = .046$), the higher the observed rate. A model with both factors has evidence that suggests that most of the effect is in the factor, year (slope for year: 0.08; $P = .038$; slope for quality of evidence: 0.49; $P = .09$). Note that a regression using evidence quality is improper, because our evidence scale is not properly ratio (eg, the distance between 6 and 7 is not necessarily equivalent to the distance between 14 and 15), but the regression is a useful exploratory device.

b. Orthopaedic Screening

Evidence was found in 25 studies (target articles 17, 23, 38–60). Three studies (target articles 43, 44, 54) provided 2 arms each.

As shown in Table 4, the positivity rate for ortho-

Fig 6. Distribution of publication years among articles in the accepted set.

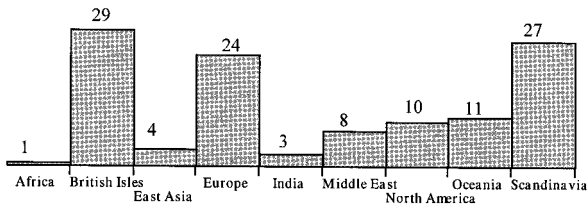
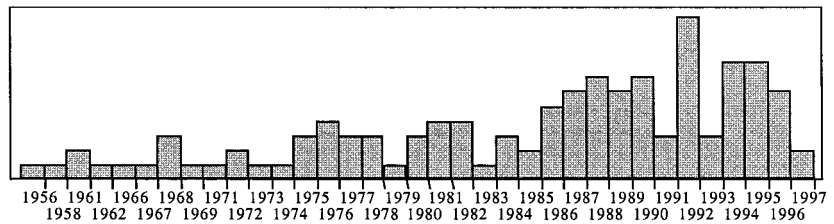

Fig 7. Distribution of accepted articles in terms of study location.

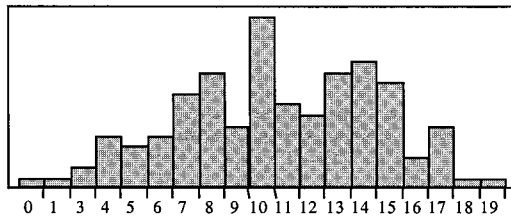

Fig 8. Distribution of evidence quality among accepted articles.

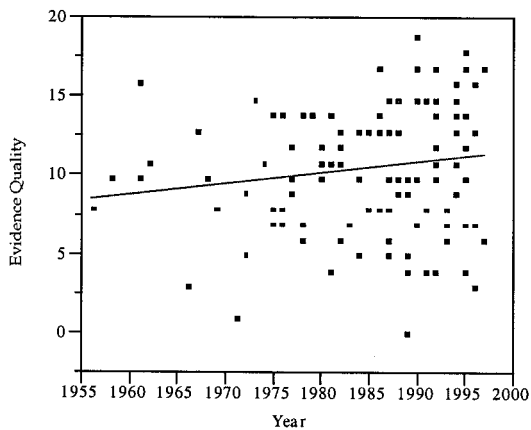

Fig 9. Evidence quality in analyzed articles by publication year. Line is a linear regression fit line whose slope is statistically not significantly different from zero.

paediatric screening is between 7 and 11/1000. One outlier study (target article 41), with an observed rate of more than 300/1000, skews the unweighted and meta-analytic averages. The estimate (between 7.1 and 11) is just below that of pediatric screening and is statistically indistinguishable. Note, however, that a fair number of studies have rates near 22/1000 or higher (Fig 13).

Unlike with pediatric screening, there are no correlations with other factors.

c. Ultrasonographic Screening

Evidence was found in 17 studies (target articles 11, 22, 25, 31, 41, 54, 61–71), each providing a single arm.

The rate for ultrasonographic screening is 20/1000 or more. Although the estimates are sensitive to pooling and to the outlier, the positivity rate is clearly higher than in either PE strategy. There are no correlating factors. In particular, studies that use the Graf method² or those that use the method of Harcke et al¹ show comparable rates.

2. Postneonatal Cases

We initially were interested in all postneonatal diagnoses of DDH. However, the literature did not provide data within the narrow time frames initially specified for our model. Based on the data that were available, we considered 3 classes of postneonatal DDH: DDH diagnosed after 12 months of age (“late-term”), DDH diagnosed between 6 and 12 months of age (“mid-term”), and DDH diagnosed before 6 months of age. There were few data for the latter group, which often was combined with the newborn screening programs. Therefore, we collected data on only the first 2 groups. The results are summarized in Table 5 and Table 6.

a. After Pediatric Screening

Evidence was found in 24 studies (target articles 1, 4, 7, 9, 12, 14, 15, 23, 25, 27, 30, 38, 40, 44, 72–81). The study by Dunn and O’Riordan (target article 14) provided 2 arms. It is difficult to discern an estimate rate for mid-term DDH, because the study by Czeizel et al (target article 40) is such an outlier, with a rate of 3.73/1000, and because the weighted and unweighted averages also differ greatly. The meta-analytic estimate of 0.55/1000 seems to be an upper limit.

The late-term rate is easier to estimate at ~0.3/1000. Although it is intuitive that the late-term rate should be lower than the mid-term rate, our data do not allow us to draw that conclusion.

b. After Orthopaedic Screening

There were only 4 studies (target articles 2, 43, 47, 55). The rates were comparable for mid- and late-

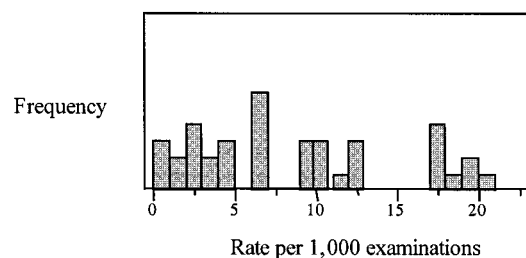

Fig 10. Distribution of rates.

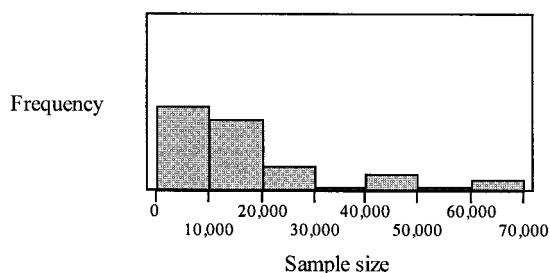

Fig 11. Distribution of sample sizes in pediatric screening studies. Outliers are excluded (studies 218 [917 865 subjects], 206 [151 924], and 350 [415 542]).

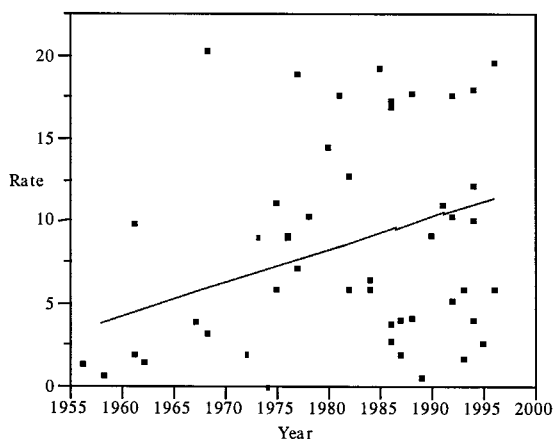

Fig 12. Plot and simple linear regression of DDH positivity rate against year, for pediatric newborn screening.

term: 0.1/1000 newborns. A meta-analytic estimate was not calculated.

c. After Ultrasonographic Screening

Only 1 study, by Rosendahl et al (target article 25) is available; it reported rates for infants with and without initial risk factors (eg, family history and breech presentation). The mid-term rate was 0.28/1000 newborns in the non-risk group, and the late-term rate was 0/1000 in the same group.

3. AVN After Treatment

For these estimates, we grouped together all treatments, because from the viewpoint of the referring primary care provider, orthopaedic treatment is a "black box." A literature synthesis that teased apart the success and complications of particular *therapeutic* strategies is beyond the scope of the present study.

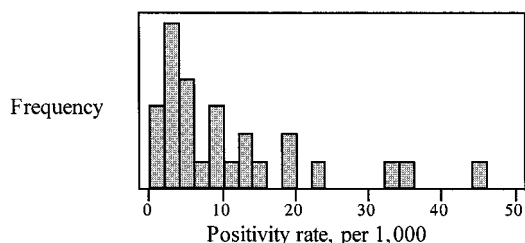

Fig 13. Distribution of observed positivity rates, excluding the outlier, target article 103.

The complication rate should depend only on the age of the patient at time of orthopaedic referral and on the type of treatment received. We report on the complication rates for children treated before and after 12 months of age.

a. After Early Referral

There were 17 studies providing evidence (target articles 2, 13, 35, 37, 42, 43, 51, 54, 58, 60, 77, 82–87). Infants were referred to orthopaedists during the newborn period in each study except 2. In the study by Pool et al (target article 84), infants were referred during the newborn period and before 2 months of age; in the study by Sochart and Paton (target article 87), infants were referred between 2 weeks and 2 months of age.

The range of AVN rates per 1000 infants referred was huge, from 0 to 123. The largest rate occurred in the study by Pool et al (target article 84), a sample-based study that included later referrals. Its evidence quality was 8, within the 7 to 13 interquartile range of the other studies in this group. As in earlier tables, the meta-analytic estimate lies between the average and weighted (pooled) average of the studies.

b. After Later Referral

Evidence was obtained from 6 studies (target articles 19, 83 [includes 2 samples], 85, 88–90). Some of the studies included children referred during the newborn period (target article 19) or during the 2-week to 2-month period (target articles 85, 89), but even in these, the majority of infants were referred later during the first year of life.

There were no outlier rates, although the highest rate (216/1000 referred children) occurred in the study with the oldest referred children in the sample (target article 83) with children referred who were older than 12 months of age). One study (target article 19) contributed 5700 patients to the analysis, more than half of the 9270 total, so its AVN rate of 27/1000 brought the unweighted rate of 116/1000 to 54. Results are summarized in Table 7. A meta-analytic estimate was not computed.

4. Risk Factors

A number of factors are known to predispose infants to DDH. We sought evidence for 3 of these: sex, obstetrical position at birth, and family history. Studies were included in these analyses only if a control group could be ascertained from the available study data.

The key measure is the odds ratio, an estimate of the relative risk. The meaning of the odds ratio is that if the DDH rate for the control group is known, then the DDH rate for the at-risk group is the product of the control-group DDH rate and the odds ratio for the risk factor. An odds ratio statistically significantly greater than 1 indicates that the factor is a risk factor.

The Bayesian meta-analysis produces estimates between the average of the odds ratios and the pooled

TABLE 5. Summary of Evidence Tables for Mid-Term (6 to 12 Months of Age) Postneonatal Diagnosis*

Initial Strategy (Arc,† Showing Initial Negative Examination)	Rate per 1000 Initial Examinations			Sample Size Average (SD)	Sample Size Total	No. of Arms§
	Unweighted Average (SD)	Weighted‡ Average (SD)	Meta-analytic Average (SD)			
Pediatric examination (3- → 20; 29, 30)	0.43 (0.77) 0.30¶ (0.35)	0 (1) 0# (0)	0.48 (0.6) 0.34¶ (0.29)	77 384¶ (164 393)	1 934 611	25
Orthopaedic examination (5- → 20; 29, 30)	0.075 (0.085)	0.1 (0.1)	ND	29 269 (9506)	117 077	4
Ultrasonographic examination (4- → 20; 29, 30)	0.28** (0.28)	...	ND	...	8001	2

ND indicates not done.

* See Evidence Tables 4, 5, and 6.

† Arc refers to the influence diagram (see Fig. 2).

‡ Weighted estimates computed by pooling the numerators and denominators of the target arms.

§ Some studies involved more than 1 arm.

¶ Without outlier (target article 23 (839 986 subjects), the mean (SD) sample size is 45 609 (43 141).

¶ Without outlier (target article 40; mid-term rate, 3.73/1000 infants).

Without outlier (target article 40; mid-term rate, 3.73/1000 infants). The median is 0.05.

** This single study had 1 arm comprising newborns without and with risk factors for DDH. The observed DDH rate for the with risk factors was 0.46 for mid-term DDH and 0.23 for late-term. The SD given is the standard error calculated from the study.

TABLE 6. Summary of Evidence Tables for Late-Term (12 Months of Age or Older) Postneonatal Diagnosis*

Initial Strategy (Arc,† Showing Initial Negative Examination)	Rate per 1000 Initial Examinations			Sample Size Average (SD)	Sample Size Total	No. of Arms§
	Unweighted Average (SD)	Weighted‡ Average (SD)	Meta-analytic Average (SD)			
Pediatric examination (3- → 29, 30)	0.21 (0.29)	0 (0)	ND	77 384¶ (164 393)	1 934 611	25
Orthopaedic examination (5- → 29, 30)	0.08 (0.10)	0.1 (0.1)	ND	29 269 (9506)	117 077	4
Ultrasonographic examination (4- → 29, 30)	0.0# (0.2)	...	ND	...	8001	2

ND indicates not done.

* See Evidence Tables 4, 5, and 6.

† Arc refers to the influence diagram (see Fig. 2).

‡ Weighted estimates computed by pooling the numerators and denominators of the target arms.

§ Some studies involved more than 1 arm.

|| The median late-term rate is 0.3.

¶ Without outlier (target article 23; 839 986 subjects), the mean (SD) sample size is 45 609 (43 141).

The SD was calculated by using a continuity correction.

odds ratio and is, therefore, the estimate we used in our later analyses.

The data for all 3 risk factors are summarized in Table 8, and in Evidence Tables 9 through 16 (see "Appendix").

a. Female

The studies were uniform in discerning a risk to girls ~4 times that of boys for being diagnosed with DDH. This risk was seen in all 3 screening environments.

b. Breech

The studies for breech also were confident in finding a risk for breech presentation, on the order of fivefold. One study (target article 65) found breech presentation to be protective, but the study was relatively small and used ultrasonography rather than PE as its outcome measure.

c. Family History

Although some studies found family history to be a risk factor, the range was wide. The confidence

TABLE 7. Summary of Evidence Tables for Development of AVN*

Age at Initial Referral (Arc†)	AVN After Orthopaedic Referral Rate per 1000 Referred Infants			Sample Size Average (SD)	Sample Size Total	No. of Arms
	Unweighted Average (SD)	Weighted‡ Average (SD)	Meta-analytic Average (SD)			
Younger than 2 mo (5, 12+ → 31)	16.6 (35)	6.4 (23)	13.5 (24)	514 (922)	7606	17
Without outliers§	2.5 (5.9)	1.5 (1.4)	2.5 (9.5)	447 (907)	...	
Older than 2 mo (20, 29, 30+ → 31)	116 (70)	54 (49)	109 (88)	1158 (1885)	9270	7

* AVN indicates avascular necrosis. See Evidence Tables 7 and 8.

† Arc refers to the influence diagram (see Fig. 2).

‡ Weighted estimates computed by pooling the numerators and denominators of the target arms.

§ Outliers are target article 83 (81/1000), target article 84 (123), and target article 60 (43).

TABLE 8. Summary of Evidence Tables for Odds Ratios*

Risk Factor/Screen (Arc†)	Odds Ratio		Meta-analytic Odds Ratio (CIS)	Sample Size		No. of Arms
	Unweighted Average (SD)	Weighted‡ Average (SD)		Average (SD)	Total	
Female						
Pediatric (1 → 3 Fe)	4.52 (2.4)	3.8 (0.05)	4.14 (3.0–5.7)	38 821 (41 729)	427 039	11
Orthopaedic (1 → 5 Fe)	4.71 (1.66)	4.38 (0.09)	4.52 (3.2–6.2)	18 982 (11 298)	75 929	4
Ultrasonographic (1 → 4 Fe)	5.84 (1.89)	1.41 (0.10)	5.16 (2.48–11.7)	3405 (1085)	10 216	3
Breech						
Pediatric (1 → 3 Br)	7.32 (8.21)	4.11 (0.06)	5.47 (2.58–11.6)	20 117 (19 492)	201 465	10
Orthopaedic (1 → 5 Br)	8.42 (4.60)	4.05 (0.07)	7.03 (4.48–11.9)	16 209 (8929)	113 464	7
Ultrasonographic (1 → 4 Br)	0.59	2000	2000	1
Family history						
Pediatric (1 → 3 FH)	4.65 (4.63)	1.09 (0.07)	1.72 (0.05–55.00)	7451 (10 424)	30 164	4
Orthopaedic (1 → 5 FH)	0
Ultrasonographic (1 → 4 FH)	2.78 (1.06)	2.85 (0.14)	2.89 (1.0–7.1)	3324 (1872)	6648	2

Fe indicates female; Br, breech; FH, family history.

* See Evidence Tables 9 through 16.

† Arc refers to the influence diagram (see Fig. 2).

‡ Weighted estimates computed by pooling the cells of the component 2 × 2 tables.

§ Bayesian confidence interval.

TABLE 9. Summary of Evidence and Estimates

Parameter (Arc)	Estimate (SD)	95% Confidence Interval	Source
Pediatric screen (1 → 3)	8.6 (7.1)	0.58–27	Meta-analysis, Table 4, studies acknowledging 3 categories
Orthopaedic screen (1 → 5)	11.5 (11)	0.48–39	Meta-analysis, excluding outlier, Table 4
US screen (1 → 4)	24.9 (23.5)	0.86–82	Meta-analysis, excluding outlier, Table 4
Mid-term postneonatal DDH			
After pediatric screen (3- → 20)	0.34 (0.29)	0–1.9	Meta-analysis, excluding outlier, Table 5
After orthopaedic screen (5- → 20)	0.1 (0.1)	0.08–0.12	Pooled and average agree, Table 5
After US screen (4- → 20)	0.28 (0.28)	0.0–0.84	Single study, standard error from the study, Table 5
Late-term postneonatal DDH			
After pediatric screen (3- → 29, 30)	0.21 (0.29)	0.0–0.79	Average; pooled is too small, Table 5
After orthopaedic screen (5- → 29, 30)	0.08 (0.10)	0.0–0.28	Average and pooled agree, Table 5
After US screen (4- → 29, 30)	0.2 (0.2)	0.0–0.4	Single study, continuity correction, Table 5. Note that this estimate is half the confidence interval and not the raw estimate from the study.
AVN after early referral (5, 12+ → 31)	2.5 (9.5)	0–27	Meta-analysis, excluding outliers, Table 7
AVN after later referral (20, 29, 30+ → 31)	109 (88)	8.2–338	Meta-analysis, Table 7
Risk factor			
Girl	4.1	3.0–5.7	Meta-analysis, pediatric, agrees with estimates for orthopaedic and US screens, Table 8
Breech	5.5	2.6–11.6	Meta-analysis, pediatric, intermediate between estimates for orthopaedic and US screens, Table 8
Family history	1.7	0.05–55	Meta-analysis, pediatric, intermediate between estimates for orthopaedic and US screens, Table 8

US indicates ultrasonographic.

intervals for the pooled odds ratio and for the Bayesian analysis contained 1.0, suggesting that family history is *not* an independent risk factor for DDH. However, because of traditional concern with this risk factor, we kept it in our further considerations.

D. Evidence Summary and Risk Implications

To bring all these evidence tables together, we constructed Table 9, which contains the estimates we chose for our recommendations. The intervals are asymmetric, in keeping with the intuition that rates near zero cannot be negative, but certainly can be very positive.

The risk implications are shown in Table 10 for infants with different risk factors. These risks are based on the pediatrician population rate of 8.6 labeled cases of DDH per 1000 infants screened. In the Subcommittee’s discussion, 50/1000 was a cutoff for automatic referral during the newborn period. Hence, girls born in the breech position are classified in a separate category for newborn strategies than infants with other risk factors.

If we use the orthopaedists’ rate as our baseline, we obtain the results shown in Table 11. Like Table 9, these numbers suggest that boys without risks or those with a family history have the lowest risk; girls

TABLE 10. Absolute Risks for Finding a Positive Examination Result at Newborn Screening Using the Method of Ortolani and Barlow

Newborn Characteristics	Risk per 1000 Newborns With Characteristics
All newborns	8.6
Boys	3
Girls	14
Positive family history	
Boys	4.8
Girls	24
Breech presentation	
Boys	18
Girls	84

TABLE 11. Relative and Absolute Risks for Finding a Positive Examination Result at Newborn Screening Using the Method of Ortolani and Barlow, Based on Orthopaedic Newborn Screening Yield

Newborn Characteristic	Relative Risk of a Positive Examination Result	Absolute Risk per 1000 Newborns With Characteristic
All newborns	...	11.5
Boys	...	4.1
Girls	4.6	19
Positive family history		
Boys	1.7	6.4
Girls	1.7	32
Breech presentation		
Boys	7.0	29
Girls	7.0	133

without risks and boys born in the breech presentation have an intermediate risk; and girls with a positive family history, and especially girls born in the breech presentation, have the highest risks. Guidelines that consider risk factors should follow these risk profiles.

E. Decision Recommendations

With the evidence synthesized, we can estimate the expected results of the target newborn strategies for postneonatal DDH and AVN. Table 12 summarizes Table 9 even further.

We use the numbers in Table 12 to arrive at summary outcomes for each initial strategy. Thus, if a case of DDH is observed in an infant with an initially negative result of screening by an orthopaedist in a newborn screening program, that case is “counted” against the orthopaedist strategy.

The numbers are combined using a simple decision tree (Fig 14), which is *not* the final tree represented by our influence diagram but is a tree that is supported by our evidence. The results are given in Table 13. The results show that pediatricians diagnose fewer newborns with DDH and perhaps have a higher postneonatal DDH rate than orthopaedists but one that is comparable to ultrasonography (acknowledging that our knowledge of postneonatal DDH revealed by ultrasonographic screening is limited). The AVN rates are comparable with pediatrician and ultrasonographic screening and less than with orthopaedist screening.

The algorithm in Fig 15 was generated by the

TABLE 12. Positive Examination Result for DDH Based on Training of Examiner and Method of Examination of the Newborn, at an Intermediate (± 6 Months of Age), and at 12 Months of Age

Age at Outcome	Strategy		
	Pediatrician PE*	Orthopaedist PE*	Ultrasonography*
Newborn	8.60	11.50	25.00
Intermediate	0.34	0.10	0.28
12 mo	0.21	0.08	0.20

* Units are the number of DDH said to be positive per 1000 examinations.

Subcommittee after review of the evidence (Table 14).

F. Cost-Effectiveness Ratios

In terms of excess neonatal referrals, the ratios suggest that there is a trade-off: for every case that these strategies detect beyond the pediatric strategy, they require more than 7000 or 16 000 extra referrals, respectively.

DISCUSSION

A. Summary

We derived 298 evidence tables from 118 studies culled from a larger set of 624 articles. Our literature review captured most in our model-based approach, if not all, of the past literature on DDH that was usable. The decision model (reduced based on available evidence) suggests that orthopaedic screening is optimal, but because orthopaedists in the published studies and in practice would differ, the supply of orthopaedists is relatively limited, and the difference between orthopaedists and pediatricians is relatively small, we conclude that pediatric screening is to be recommended. The place of ultrasonography in the screening process remains to be defined because there are too few data about postneonatal diagnosis by ultrasonographic screening to permit definitive recommendations.

Our conclusions are tempered by the uncertainties resulting from the wide range of the evidence. The confidence intervals are wide for the primary parameters. The uncertainties mean that, even with all the evidence collected from the literature, we are left with large doubts about the values of the different parameters.

Our data do not bear directly on the issue about the earliest point that *any* patient destined to have DDH will show signs of the disease. Our use of the terms *mid-term* and *late-term* DDH addresses that ignorance.

Our conclusions about other areas of the full decision model are more tentative because of the paucity of data about the effectiveness of periodicity examinations. Even the studies that gave data on mid-term and late-term case findings by pediatricians were sparse in their details about how the screening was instituted, maintained, or followed up.

Our literature search was weakest in addressing the European literature, where results about ultrasonography are more prevalent. We found, however,

Fig 14. Simplified tree for calculating implications of different newborn screening strategies. DDH "+" indicates a positive examination result. The terms beginning with "p" denote variables whose values were set by the evidence collected. "#" denotes the complement (1 minus) the alternate term.

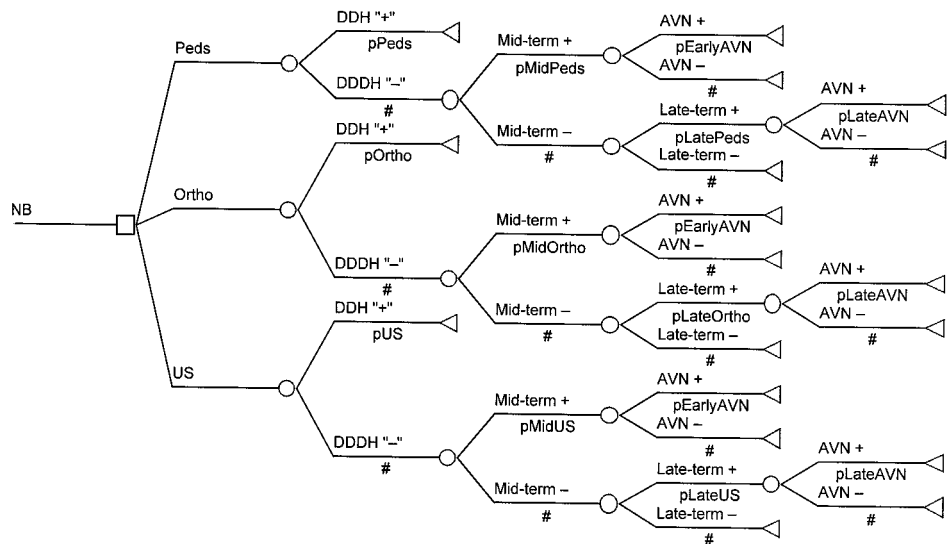

TABLE 13. Expected Outcomes for Different Screening Strategies

	Newborn Screening Strategy (Outcome per 10 000 Newborns Screened)		
	Pediatrician	Orthopaedist	Ultrasonography
DDH			
Newborn	86	115	250
Mid-term	3.4	1	2.7
Late-term	2.1	0.8	1.9
AVN at 12 mo	0.2	0.1	0.2

that many of the seminal articles were republished in English or in a form that we could assess.

B. Specific Issues

1. Evidence Quality

Our measure of evidence quality is unique, although it is based on solid principles of study design and decision modeling. In particular, our measure was based on the notion that if the data conform poorly to how we need to use it, we downgrade its value.

However, throughout the analyses, there was never a correlation with the results of a study (in terms of the values of outcomes) and with evidence quality, so we never needed to use the measure for weighting the values of the outcome or for culling articles from our review. Had this been so, the measures would have needed further scrutiny and validation.

2. Outliers

Perhaps the true surrogates for study quality were the outlying values of outcomes. In general, however, there were few cases in which the outliers were clearly the result of poor-quality studies. One example is that of the outcomes of pediatric screening (1 → 3), in which the DDH rates in studies using only 2 categories were generally higher than those that explicitly specified 3 levels of outcomes.

Our general justification for using estimates that excluded outliers is that the outliers so much drove the results that they dominated the conclusion out of proportion to their sample sizes. As it is, our estimates have wide ranges.

3. Newborn Screening

The set of studies labeled "pediatrician screening" includes studies with a variety of examiners. We could not estimate the sensitivity and specificity of pediatricians' examinations versus those of other primary care providers versus orthopaedists. There are techniques for extracting these measures from agreement studies, but they are beyond the scope of the present study. It is intuitive that the more cases that one examines, the better an examiner one will be, regardless of professional title.

We were surprised that the results did not show a clear difference in results between the Graf² and Harcke et al¹ ultrasonographic examinations. Our data make no statement about the relative advantages of these methods for following up children or in addressing treatment.

4. Postneonatal Cases

As mentioned, our data cannot say *when* a postneonatal case is established or, therefore, the best time to screen children. We established our initial age categories for postneonatal cases based on biology, treatment changes, and optimal imaging and examination strategies. It is frustrating that the data in the literature are not organized to match this pathophysiological way of thinking about DDH. Similarly, as mentioned, the lack of details by authors on the methods of intercurrent screening means that we cannot recommend a preferred method for mid-term or late-term screening.

5. AVN

We used AVN as our primary marker for treatment morbidity. We acknowledge that the studies we grouped together may reflect different philoso-

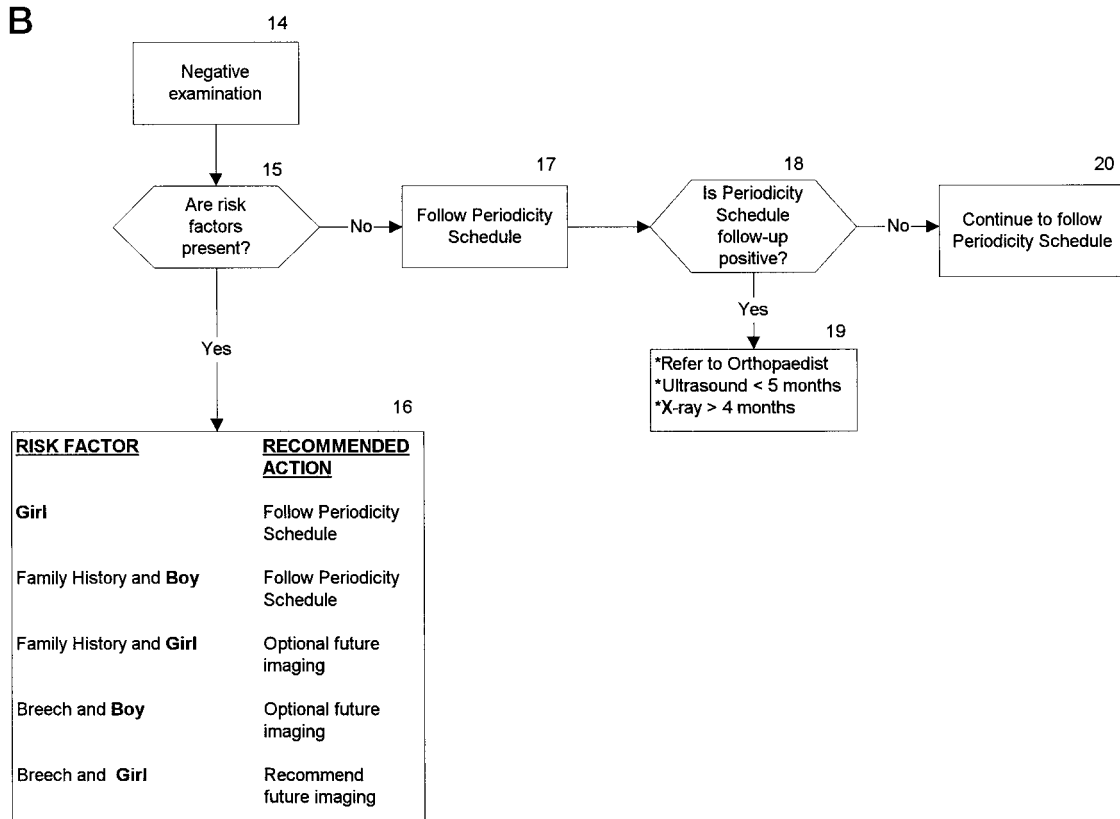
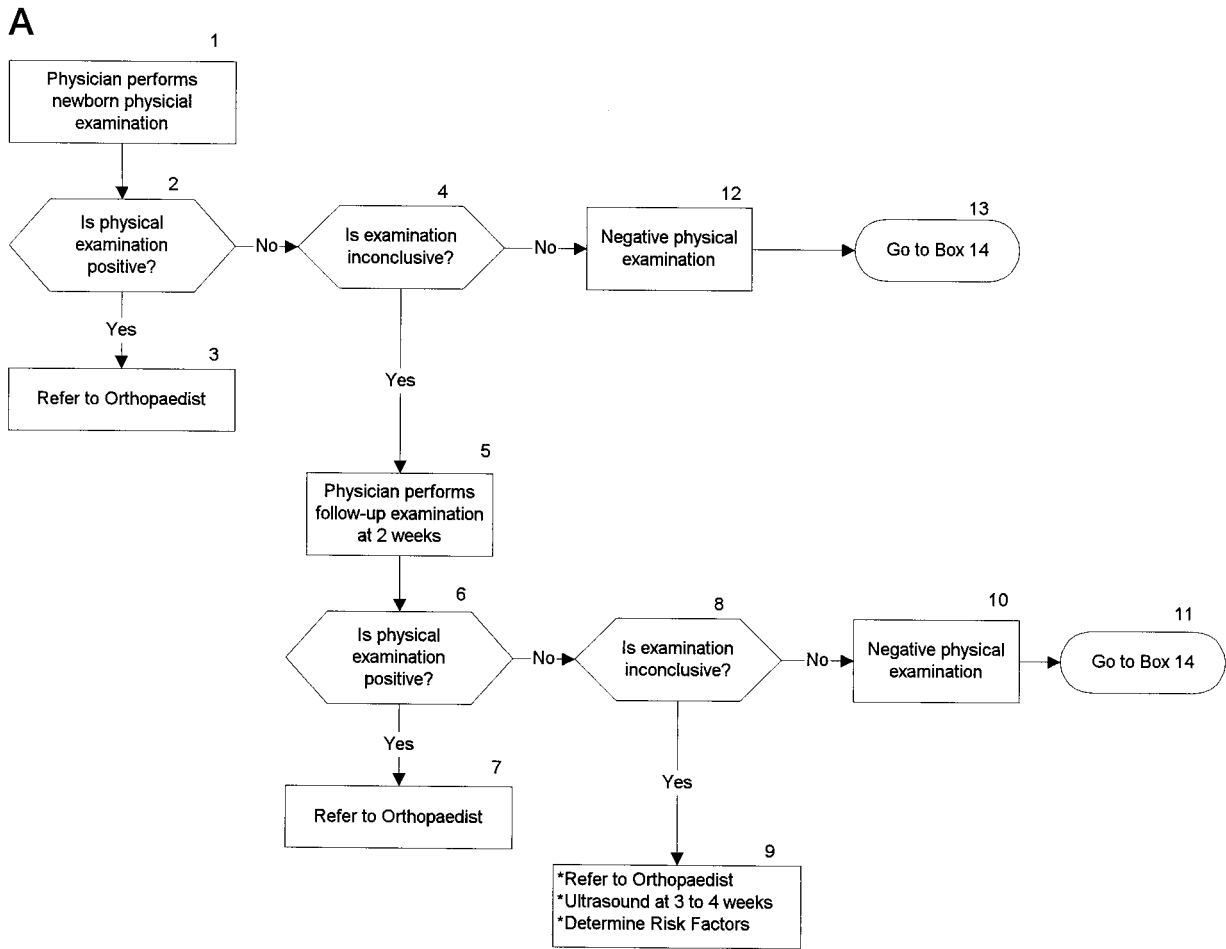

Fig 15. Parameter flowchart.

TABLE 14. Recommendations, Evidence, and Consensus of the Subcommittee

Index to Diagram	Recommendation	Evidence	Consensus
1	NB screen	Direct (arc 1 → 3); although orthopaedic screening would be optimal, it is doubtful that such a strategy widely practiced would give the same good results as those of pediatric orthopaedic study centers.	Strong
1	Post-NICU examination	Direct; there is some suggestion that NICU infants may be at higher risk.	Strong
	Examination by properly trained personnel	Direct (arc 1 → 3); a number of studies performed by properly trained nonphysicians report results indistinguishable from those performed by physicians.	Strong
	Do not perform US for all infants	Indirect (arc 1 → 4 plus decision model); that strategy results in no lower postneonatal DDH rates and may result in higher AVN rates.	Strong
4	PE ++: refer to orthopaedist	Direct (arc 3 → 5)	Optional
4	PE ++: follow-up in 2 wk	Direct (target article 96)	Strong
	PE ++: do not order US now	Direct (arc 3 → 4)	Strong
	PE ++: do not order radiographs	Direct (not from our review); radiographs are too insensitive at this age owing to lack of calcification.	Strong
	PE ++: do not triple diaper	Indirect	Strong; a true positive examination should be actively managed, and triple diapering is not an effective treatment modality.
	PE positive or negative: triple diaper	Indirect	Optional; diapering may communicate a sense of concern and may promote compliance.
5	If PE positive or negative, follow-up in 2 wk	3 → 4 (target article 96); 80% resolves spontaneously	Fair
6	If PE positive at 2-wk follow-up, refer to orthopaedist now or perform US at 3 wk	Indirect because rate decreases from 10/1000 to a lesser number, but DDH does not resolve (target article 38)	Strong
7	If PE negative, continue with periodicity examinations	Direct; diagnosis before 6 mo decreases AVN/DDH morbidity	Strong
12	Risk factors	Direct; the evidence is strongest for family history, female sex, and breech presentation. Other risk factors include left hip involvement and prematurity. We do not include left hip because no one will examine one hip and not the other. We do not include prematurity because the overall data are unclear about its implications.	Strong
13	If family history positive, perform periodic examinations	Absolute risk is 9–44/1000	Strong; consensus threshold for imaging is 50/1000
13	If girl, perform periodic examinations	Absolute risk is 12–19/1000	Strong
10	If boy breech, perform periodic examinations, with optional imaging	Absolute risk is 17–26/1000	Strong
8	If girl breech, refer to orthopaedist immediately or perform US at 3–6 wk	Absolute risk is 70–120/1000	Strong
9	If periodic examination positive, refer to orthopaedist immediately or image (US if <5 mo or radiographs if >4 mo)	Indirect; imaging may be acceptable if imager has requisite experience in interpreting results.	Strong for referral; fair for imaging

NB indicates newborn; NICU, neonatal intensive care unit; US, ultrasonography. Two plus signs indicate strongly positive.

phies and results of orthopaedic practice. The hierarchical meta-analysis treats every study as an individual case, and the wide range in our confidence intervals reflects the uncertainty that results in grouping disparate studies together.

C. Comments on Methods

This study is unique in its strong use of decision modeling at each step in the process. In the end, our results are couched in traditional terms (estimated

rates of disease or morbidity outcomes), although the context is relatively nontraditional: attaching the estimates to *strategies* rather than to treatments. In this, our study is typical of an *effectiveness* study, which studied results in the real world, rather than of an *efficacy* study, which examines the biological effects of a treatment.¹¹

We made strong and recurrent use of the Bayesian hierarchical meta-analysis. A review of the tables will confirm that the Bayesian results were in the same “ballpark” as the average and pooled average estimates and had a more solid grounding.

The usual criticism of using Bayesian methods is that they depend on prior belief. The usual response is to show that the final estimates are relatively insensitive to the prior belief. In fact, for the screening strategies, a wide range of prior beliefs had no effect on the estimate. However, the prior belief used for the screening strategies—with a mean of 100 cases/1000 with a variance of 100—was too broad for the postneonatal case and AVN analyses; when data were sparse, the prior belief overwhelmed the data. For instance, in late-term DDH revealed by orthopaedic screening (5→30), in an analysis not shown, the posterior estimate from the 4 studies was a rate of 0.345 cases per 1000, despite an average and a pooled average on the order of 0.08. Four studies were insufficient to overpower a prior belief of 100.

D. Research Issues

The place of ultrasonography in DDH screening needs more attention, as does the issue of intercurrent pediatrician screening. In the latter case, society and health care systems must assess the effectiveness of education and the “return on investment” for educational programs. The place of preferences—of the parents, of the clinician—must be established.

We hope that the framework we have delineated—of a decision model and of data—can be useful in these future research endeavors.

ACKNOWLEDGMENTS

We thank Robert Sebring, PhD, for helping to manage this process and for substantive input and Bonnie Cosner for helping to manage the workflow.

We also thank Chris Kwiat, MLS, from the American Academy of Pediatrics Library, who performed the literature searches.

V. REFERENCES

1. Harcke HT, Lee MS, Borns PF, MacEwen GD. Examination of the infant hip with real-time ultrasonography. *J Ultrasound Med*. 1984;3:131–137
2. Graf R. Classification of hip joint dysplasia by means of sonography. *Arch Orthop Trauma Surg*. 1984;102:248–255
3. Howard RA, Matheson JE. Influence diagrams. In: Matheson JE, ed. *Readings on the Principles and Applications of Decision Analysis*. Menlo Park, CA: Strategic Decisions Group; 1981:720–762
4. Owen DL. The use of influence diagrams in structuring complex decision problems. In: Howard RA, Matheson JE, eds. *Readings on the Principles and Applications of Decision Analysis*. Menlo Park, CA: Strategic Decisions Group; 1983:763–772
5. Nease RF, Owens DK. Use of influence diagrams to structure medical decisions. *Med Decis Making*. 1997;17:263–275
6. Eddy DM. The confidence profile method: a Bayesian method for assessing health technologies. *Operations Res*. 1989;37:210–228
7. Gelman A, Carlin JB, Stern HS, Rubin DB. *Bayesian Data Analysis*. London, UK: Chapman & Hall; 1997

8. DerSimonian R, Laird N. Meta-analysis in clinical trials. *Control Clin Trials*. 1986;7:177–188
9. Spiegelhalter D, Thomas A, Best N, Gilks W. *BUGS 0.5: Bayesian Inference Using Gibbs Sampling Manual, II*. Cambridge, MA: MRC Biostatistics Unit, Institute of Public Health; 1996. Available at: <http://www.mrc-bsu.cam.ac.uk/bugs/software/software.html>. Accessed March 15, 1999
10. Berger JO. *Statistical Decision Theory and Bayesian Analysis*. 2nd ed. New York, NY: Springer-Verlag; 1985
11. Fletcher RH, Fletcher SW, Wagner EH. *Clinical Epidemiology: The Essentials*. 2nd ed. Baltimore, MD: Williams & Wilkins; 1988

TARGET ARTICLES

1. Clarke NM, Clegg J, Al-Chalabi AN. Ultrasound screening of hips at risk for CDH: failure to reduce the incidence of late cases. *J Bone Joint Surg Br*. 1989;71:9–12
2. Fiddian NJ, Gardiner JC. Screening for congenital dislocation of the hip by physiotherapists: results of a ten-year study. *J Bone Joint Surg Br*. 1994;76:458–459
3. Boeree NR, Clarke NM. Ultrasound imaging and secondary screening for congenital dislocation of the hip. *J Bone Joint Surg Br*. 1994;76:525–533
4. Bjerkeim I, Hagen O, Ikonomou N, Kase T, Kristiansen T, Arseth P. Late diagnosis of developmental dislocation of the hip in Norway during the years 1980–1989. *J Pediatr Orthop B*. 1993;2:112–114
5. Bjerkeim I, Johansen J. Late diagnosed congenital dislocation of the hip. *Acta Orthop Scand*. 1987;58:504–506
6. Andren L, von Rosen S. The diagnosis of dislocation of the hip in newborns and the primary results of immediate treatment. *Acta Radiol*. 1958;49:89–95
7. Bertol P, Macnicol M, Mitchell G. Radiographic features of neonatal congenital dislocation of the hip. *J Bone Joint Surg Br*. 1982;64:176–179
8. Bialik V, Fishman J, Katzir J, Zeltzer M. Clinical assessment of hip instability in the newborn by an orthopedic surgeon and a pediatrician. *J Pediatr Orthop*. 1986;6:703–705
9. Bower C, Stanley F, Kricker A. Congenital dislocation of the hip in Western Australia: a comparison of neonatally and postneonatally diagnosed cases. *Clin Orthop*. 1987;224:37–44
10. Chaitow J, Lillystone D. Congenital dislocation of the hip: incidence, and treatment of a local population group. *Med J Aust*. 1984;140:534–535
11. Clarke N. Sonographic clarification of the problems of neonatal hip instability. *J Pediatr Orthop*. 1986;6:527–532
12. Doig J, Shannon F. Congenital dislocation of the hip: an evaluation of neonatal diagnosis. *N Z Med J*. 1975;82:367–369
13. Dunn P, Evans R, Thearle M, Griffiths H, Witherow P. Congenital dislocation of the hip: early and late diagnosis and management compared. *Arch Dis Child*. 1985;60:407–414
14. Dunn D, O’Riordan S. Late diagnosis of congenital dislocation of the hip. *Dev Med Child Neurol*. 1981;23:202–207
15. Finlay H, Maudsley R, Busfield P. Dislocatable hip and dislocated hip in the newborn infant. *Br Med J*. 1967;4:377–381
16. Garvey M, Donoghue V, Gorman W, O’Brien N, Murphy J. Radiographic screening at four months of infants at risk for congenital hip dislocation. *J Bone Joint Surg Br*. 1992;74:704–707
17. Gupta A, Kumari S, Arora P, Kumar R, Mehtani A, Sood L. Hip instability in newborns in an urban community. *Natl Med J India*. 1992;5:269–272
18. Hansson G, Romanus B, Scheller S. Pitfalls of early diagnosis and treatment of congenital dislocation of the hip joint. *Arch Orthop Trauma Surg*. 1988;107:129–135
19. Heikkilä E, Ryöppy S, Louhimo I. Late diagnosis in congenital dislocation of the hip. *Acta Orthop Scand*. 1984;55:256–260
20. Hiertonn T, James U. Congenital dislocation of the hip: experiences of early diagnosis and treatment. *J Bone Joint Surg Br*. 1968;50:542–545
21. Hinderaker T, Daltveit AK, Irgens LM, Uden A, Reikeras O. The impact of intra-uterine factors on neonatal hip instability: an analysis of 1,059,479 children in Norway. *Acta Orthop Scand*. 1994;65:239–242
22. Holen KJ, Terjesen T, Tegnander A, Bredland T, Saether OD, Eik-Nes SH. Ultrasound screening for hip dysplasia in newborns. *J Pediatr Orthop*. 1994;14:667–673
23. Palmén K. Preluxation of the hip joint: diagnosis and treatment in the newborn and the diagnosis of congenital dislocation of the hip

- joint in Sweden during the years 1948–1960. *Acta Paediatr Suppl.* 1961;50:1–71
24. Phillips L. Congenital dislocation of the hip in the newborn: a survey at National Women's Hospital 1954–68. *N Z Med J.* 1968;68:103–108
 25. Rosendahl K, Markestad T, Lie RT. Ultrasound screening for developmental dysplasia of the hip in the neonate: the effect on treatment rate and prevalence of late cases. *Pediatrics.* 1994;94:47–52
 26. Rosendahl K, Markestad T, Lie RT. Developmental dysplasia of the hip: a population-based comparison of ultrasound and clinical findings. *Acta Paediatr.* 1996;85:64–69
 27. Tanabe G, Kotakemori K, Miyake Y, Mohri M. Early diagnosis of congenital dislocation of the hip. *Acta Orthop Scand.* 1972;43:511–522
 28. von Rosen S. Diagnosis and treatment of congenital dislocation of the hip joint in the new-born. *J Bone Joint Surg Br.* 1962;44B:284–291
 29. Darmonov AV. Clinical screening for congenital dislocation of the hip. *J Bone Joint Surg Am.* 1996;78:383–388
 30. Gardiner HM, Dunn PM. Controlled trial of immediate splinting versus ultrasonographic surveillance in congenitally dislocatable hips. *Lancet.* 1990;336:1553–1556
 31. Dorn U, Hattwich M. Sonographisches huftscreening bei neugeborenen. *Ultraschall Klin Preax.* 1987;2:159–164
 32. Medbö IU. Early diagnosis and treatment of hip joint dysplasia. *Acta Orthop Scand.* 1961;31:282–315
 33. Bjerkedal T, Bakkeiteig LS. Surveillance of congenital malformations and other conditions of the newborn. *Int J Epidemiol.* 1975;4:31–36
 34. Manning D, Hensley O, Lenehan P, O'Brien N. Unstable hip in the newborn. *Ir Med J.* 1982;75:463–464
 35. Fiddian NJ, Gardiner JC. Screening for congenital dislocation of the hip by physiotherapists. *J Bone Joint Surg Br.* 1993;76:458–459
 36. Tibrewala NS, Pai PM. Congenital malformations in the newborn period. *Indian Pediatr.* 1974;11:403–407
 37. Fredensborg N, Nilsson BE. Overdiagnosis of congenital dislocation of the hip. *Clin Orthop.* 1976;119:89–92
 38. Bernard A, O'Hara J, Bazin S, Humby B, Jarrett R, Dwyer N. An improved screening system for the early detection of congenital dislocation of the hip. *J Pediatr Orthop.* 1987;7:277–282
 39. Burger B, Burger J, Bos C, Obermann W, Rozing P, Vandenbroucke J. Neonatal screening and staggered early treatment for congenital dislocation or dysplasia of the hip. *Lancet.* 1990;336:1549–1553
 40. Czeizel A, Vizkelety T, Szentpeteri J. Congenital dislocation of the hip in Budapest, Hungary. *Br J Prev Soc Med.* 1972;26:15–22
 41. Deimel D, Breuer D, Alaiyan H, Mittelmeier H. Development assessment of a hip ultrasonographic screening program for the early diagnosis of congenital hip dysplasia at the orthopedic university department Homburg/Saar from 1986 to 1990 [in German]. *Z Orthop Ihre Grenzgeb.* 1994;132:255–259
 42. Hadlow V. Congenital dislocation of the hip over a ten-year period. *N Z Med J.* 1979;89:126–128
 43. Hadlow V. Neonatal screening for congenital dislocation of the hip: a prospective 21-year survey. *J Bone Joint Surg Br.* 1988;70:740–743
 44. Jones D. An assessment of the value of examination of the hip in the newborn. *J Bone Joint Surg Br.* 1977;59:318–322
 45. Khan M, Benjamin B. Congenital hip instability in hospital born neonates in Abha. *Ann Saudi Med.* 1992;12:184–187
 46. Krikler S, Dwyer N. Comparison of results of two approaches to hip screening in infants. *J Bone Joint Surg Br.* 1992;74:701–703
 47. Lehmann EC, Street DG. Neonatal screening in Vancouver for congenital dislocation of the hip. *CMAJ.* 1981;124:1003–1008
 48. Macnicol M. Results of a 25-year screening programme for neonatal hip instability. *J Bone Joint Surg Br.* 1990;72:1057–1060
 49. Paterson D. The early diagnosis and treatment of congenital dislocation of the hip. *Aust N Z J Surg.* 1976;46:359–366
 50. Pompe van Meerdervoort HF. Congenital musculoskeletal malformation in South African Blacks: a study of incidence. *S Afr Med J.* 1976;50:1853–1855
 51. Poul J, Bajerova J, Sommernitz M, Straka M, Pokorny M, Wong F. Early diagnosis of congenital dislocation of the hip. *J Bone Joint Surg Br.* 1992;74:695–700
 52. Rao S, Thurston A. Congenital dislocation of hip in the newborn: a postnatal survey. *N Z Med J.* 1986;99:752–754
 53. Smaill G. Congenital dislocation of the hip in the newborn. *J Bone Joint Surg Br.* 1968;50:524–536
 54. Tonnis D, Storch K, Ulbrich H. Results of newborn screening for CDH with and without sonography and correlation of risk factors. *J Pediatr Orthop.* 1990;10:145–152
 55. Tredwell S, Bell H. Efficacy of neonatal hip examination. *J Pediatr Orthop.* 1981;1:61–65
 56. Watanabe M, Yanagisawa M. Late diagnosis of congenital dislocation of the hip in the newborn. *Fukushima J Med Sci.* 1988;34:75–80
 57. Yngve D, Gross R. Late diagnosis of hip dislocation in infants. *J Pediatr Orthop.* 1990;10:777–779
 58. Gross RH, Wisnefske M, Howard TC, Hitch M. The Otto Aufrane Award paper: infant hip screening. *Hip.* 1982;1982:50–67
 59. Artz TD, Levine DB, Lim WN, Salvati EA, Wilson PD. Neonatal diagnosis, treatment and related factors of congenital dislocation of the hip. *Clin Orthop.* 1975;110:112–136
 60. Hirsch C, Scheller S. Result of treatment from birth of unstable hips. *Clin Orthop.* 1969;62:162–166
 61. Andersson JE, Funnemark PO. Neonatal hip instability: screening with anterior-dynamic ultrasound method. *J Pediatr Orthop.* 1995;15:322–324
 62. Berman L, Klenerman L. Ultrasound screening for hip abnormalities: preliminary findings in 1001 neonates. *Br Med J (Clin Res Ed).* 1986;293:719–722
 63. Castelein R, Sauter A. Ultrasound screening for congenital dysplasia of the hip in newborns: its value. *J Pediatr Orthop.* 1988;8:666–670
 64. Castelein R, Sauter A, de Vlieger M, van Linge B. Natural history of ultrasound hip abnormalities in clinically normal newborns. *J Pediatr Orthop.* 1992;12:423–427
 65. de Pellegrin M. Ultrasound screening for congenital dislocation of the hip: results and correlations between clinical and ultrasound findings. *Ital J Orthop Traumatol.* 1991;17:547–553
 66. Ganger R, Grill F, Leodolter S. Ultrasound screening of the hip in newborns: results and experience. *J Pediatr Orthop B.* 1992;1:45–49
 67. Jones D, Powell N. Ultrasound and neonatal hip screening: a prospective study of "high risk" babies. *J Bone Joint Surg Br.* 1990;72:457–459
 68. Langer R. Ultrasonic investigation of the hip in newborns in the diagnosis of congenital hip dislocation: classification and results of a screening program. *Skeletal Radiol.* 1987;16:275–279
 69. Marks DS, Clegg J, al-Chalabi AN. Routine ultrasound screening for neonatal hip instability: can it abolish late-presenting congenital dislocation of the hip? *J Bone Joint Surg Br.* 1994;76:534–538
 70. Baronciani D, Atti G, Andiloro F, et al. Screening for developmental dysplasia of the hip: from theory to practice. *Pediatrics.* 1997;99(2). URL: <http://www.pediatrics.org/cgi/content/full/99/2/e5>. Accessed February 3, 1999
 71. Exner GU. Ultrasound screening for hip dysplasia in neonates. *J Pediatr Orthop.* 1988;8:656–660
 72. Hazel J, Beals R. Diagnosing dislocation of the hip in infancy. *West J Med.* 1989;151:39–41
 73. Heikkilä E. Congenital dislocation of the hip in Finland: an epidemiologic analysis of 1035 cases. *Acta Orthop Scand.* 1984;55:125–129
 74. MacKenzie I, Wilson J. Problems encountered in the early diagnosis and management of congenital dislocation of the hip. *J Bone Joint Surg Br.* 1981;63:38–42
 75. Mendes D, Roffman M. Early detection and treatment of congenital dislocation of the hip in the newborn. *Isr J Med Sci.* 1980;16:247–249
 76. Monk C, Dowd G. Monthly screening in the first six months of life for congenital hip dislocation. *Isr J Med Sci.* 1980;16:253–256
 77. Noble T, Pullan C, Craft A, Leonard M. Difficulties in diagnosing and managing congenital dislocation of the hip. *Br Med J.* 1978;2:620–623
 78. Place M, Parkin D, Fritton J. Effectiveness of neonatal screening for congenital dislocation of the hip. *Lancet.* 1978;2:249–250
 79. Sanfridson J, Redlund-Johnell I, Uden A. Why is congenital dislocation of the hip still missed? Analysis of 96,891 infants screened in Malmö 1956–1987. *Acta Orthop Scand.* 1991;62:87–91
 80. Fredensborg N. The effect of early diagnosis of congenital dislocation of the hip. *Acta Paediatr Scand.* 1976;65:323–328
 81. Bjerkreim I, Årseth PH. Congenital dislocation of the hip in Norway: late diagnosis CDH in the years 1970 to 1974. *Acta Paediatr Scand.* 1978;67:329–332
 82. Al-Uzman K, Ahlberg A, Dawodu A, El-Mouzan M, Ahmad F. Neonatal screening for hip instability: five years' experience. *Ann Saudi Med.* 1988;8:425–429
 83. Kruczynski J. Avascular necrosis of the proximal femur in developmental dislocation of the hip: incidence, risk factors, sequelae and MR imaging for diagnosis and prognosis. *Acta Orthop Scand Suppl.* 1996;67:1–48
 84. Pool R, Foster B, Paterson D. Avascular necrosis in congenital hip dislocation: the significance of splintage. *J Bone Joint Surg Br.* 1986;68:427–430

85. Szulc W. The frequency of occurrence of congenital dysplasia of the hip in Poland. *Clin Orthop*. 1991;272:100–102
86. Teanby DN, Paton RW. Ultrasound screening for congenital dislocation of the hip: a limited targeted programme. *J Pediatr Orthop*. 1997;17:202–204
87. Sochart DH, Paton RW. Role of ultrasound assessment and harness treatment in the management of developmental dysplasia of the hip. *Ann R Coll Surg Engl*. 1996;78:505–508
88. Burgos J, Gonzalez-Herranz P, Ocete G, Rapariz JM. Secondary avascular necrosis after treatment for congenital dislocation of the hip. *J Pediatr Orthop B*. 1995;4:188–193
89. Suzuki S, Yamamuro T. Avascular necrosis in patients treated with the Pavlik harness for congenital dislocation of the hip. *J Bone Joint Surg Am*. 1990;72:1048–1055
90. Theodorou S, Gerostathopoulos N. Congenital dislocation of the hip: observations on the early diagnosis and results of treatment with an abduction brace in infants two to nine months of age in Greece. *Clin Orthop*. 1989;246:22–29
91. Basch M, Bialik V, Fishman J. Early diagnosis at the CDH clinic. *Isr J Med Sci*. 1980;16:250–252
92. Beckman L, Lemperg R, Nordström M. Congenital dislocation of the hip joint in northern Sweden. *Clin Genet*. 1977;11:151–153
93. Bialik V, Reuveni A, Pery M, Fishman J. Ultrasonography in developmental displacement of the hip: a critical analysis of our results. *J Pediatr Orthop*. 1989;9:154–156
94. Bialik V, Wiener F, Benderly A. Ultrasonography and screening in developmental displacement of the hip. *J Pediatr Orthop B*. 1992;1:51–54
95. Boo N, Rajaram T. Congenital dislocation of hips in Malaysian neonates. *Singapore Med J*. 1989;30:368–371
96. Bower C, Stanley F, Morgan B, Slattery H, Stanton C. Screening for congenital dislocation of the hip by child-health nurses in Western Australia. *Med J Aust*. 1989;150:61–65
97. Cyvin KB. Congenital dislocation of the hip joint. *Acta Paediatr Scand Suppl*. 1977;263:1–67
98. Diaz A, Abril JC, Cuervo M. Hip screening in children: comparison of various ultrasonographic methods [in German]. *Z Orthop Ihre Grenzgeb*. 1995;133:539–542
99. Franchin F, Lacalendola G, Molfetta L, Mascolo V, Quagliarella L. Ultrasound for early diagnosis of hip dysplasia. *Ital J Orthop Traumatol*. 1992;18:261–269
100. Hay S. Incidence of selected congenital malformations in Iowa. *Am J Epidemiol*. 1971;94:572–584
101. Holen KJ, Tegnander A, Terjesen T, Johansen OJ, Eik-Nes SH. Ultrasonographic evaluation of breech presentation as a risk factor for hip dysplasia. *Acta Paediatr*. 1996;85:225–229
102. Jimenez C, Delgado-Rodriguez M, Lopez-Moratalla M, Sillero M, Galvez-Vargas R. Validity and diagnostic bias in the clinical screening for congenital dysplasia of the hip. *Acta Orthop Belg*. 1994;60:315–321
103. Lennox I, McLauchlan J, Murali R. Failures of screening and management of congenital dislocation of the hip. *J Bone Joint Surg Br*. 1993;75:72–75
104. Lotito F, Sansò, Giustardi A, Cigala F. Correlation between Ortolani's sign and sonographic image in 62 hips affected by DDH. Presented at: the annual meeting of the Pediatric Orthopaedics Society of North America; April 30 to May 4, 1995; Miami, FL. Abstract 1
105. Medalie J, Makin M, Alkalay E, Yofe J, Cochavi Z, Ehrlich D. Congenital dislocation of the hip: a clinical-epidemiological study, Jerusalem 1954 to 1960. I. Retrospective incidence study. *Isr J Med Sci*. 1966;2:212–217
106. Patterson CC, Kernohan WG, Mollan RA, Haugh PE, Trainor BP. High incidence of congenital dislocation of the hip in Northern Ireland. *Paediatr Perinat Epidemiol*. 1995;9:90–97
107. Rosendahl K, Markestad T, Lie R. Congenital dislocation of the hip: a prospective study comparing ultrasound and clinical examination. *Acta Paediatr*. 1992;81:177–181
108. Rosendahl K, Aslaksen A, Lie RT, Markestad T. Reliability of ultrasound in the early diagnosis of developmental dysplasia of the hip. *Pediatr Radiol*. 1995;25:219–224
109. Stoffelen D, Uurlus M, Molenaers G, Fabry G. Ultrasound, radiographs, and clinical symptoms in developmental dislocation of the hip: a study of 170 patients. *J Pediatr Orthop B*. 1995;4:194–199
110. Vedantam R, Bell M. Dynamic ultrasound assessment for monitoring of treatment of congenital dislocation of the hip. *J Pediatr Orthop*. 1995;15:725–728
111. Walther T. Congenital dysplasia of the hip joint in newborn infants [luxatio et subluxatio coxae congenita]. *Acta Paediatr*. 1956;45:475–478
112. Clarke NMP, Harcke HT, McHugh P, Lee MS, Borns PF, MacEwen GD. Real-time ultrasound in the diagnosis of congenital dislocation and dysplasia of the hip. *J Bone Joint Surg Br*. 1985;67:406–412
113. Zieger M, Schulz RD. Ultrasonography of the infant hip. III. Clinical application. *Pediatr Radiol*. 1987;17:226–232
114. Terjesen T. Ultrasound as the primary imaging method in the diagnosis of hip dysplasia in children aged <2 years. *J Pediatr Orthop B*. 1996;5:123–128
115. Ritter MA. Congenital dislocation of the hip in the newborn. *Arch Dis Child*. 1973;125:30–32
116. Catford JC, Bennet GC, Wilkinson JA. Congenital hip dislocation: an increasing and still uncontrolled disability? *Br Med J*. 1982;285:1527–1530
117. van Moppes FI, de Jong RO. Ultrasound follow-up of the "immature" infant hip. *J Med Imaging*. 1988;2:10–15
118. Kulshrestha R, Nath LM, Upadhyaya P. Congenital malformations in live born infants in a rural community. *Indian Pediatr*. 1983;20:45–49

VI. APPENDIX: EVIDENCE TABLES

Starting on next page.

EVIDENCE TABLE 1. Pediatric Newborn Screening

Target Article No.	Author	Year	Location	Three Categories*	Positive Rate per 1000†	Population • Sample X	Sample (Population) Size	Evidence Quality
29	Darmonov	1996	Stara Zagor, Bulgaria	Yes	6.07	X	20 417	7
26	Rosendahl et al	1996	Bergen, Norway	Yes	19.65	X	3613	16
3	Boeree and Clarke	1994	Southampton, England	Yes	4.16	•	26 952	15
21	Hinderaker et al	1994	Norway	Yes	10.22	•	917 865	11
22	Holen et al	1994	Trondheim, Norway	Yes	12.33	X	4459	14
25	Rosendahl et al	1994	Bergen, Norway	Yes	18.09	•	3924	15
35	Fiddian and Gardiner	1993	Poole, England	Yes	6.01	•	42 421	7
35	Fiddian and Gardiner	1993	Poole, England	Yes	1.96	•	11 251	7
16	Garvey et al	1992	Dublin, Ireland	Yes	10.39	X	13 662	12
17	Gupta et al	1992	New Delhi, India	Yes	17.75	X	6029	11
30	Gardiner and Dunn	1990	Bristol, England	Yes	9.27	X	16 286	17
18	Hansson et al	1988	Göteborg, Sweden	Yes	17.84	•	65 865	9
31	Dorn and Hattwich	1987	Salzburg, Austria	Yes	2.16	X	6014	13
9	Bower et al	1987	Nedlands, Australia	Yes	4.24	•	67 683	6
8	Bialik et al	1986	Haifa, Israel	Yes	3.96	•	12 891	8
11	Clarke	1986	Birmingham, England	Yes	17.39	X	115	17
8	Bialik et al	1986	Haifa, Israel	Yes	2.95	•	5087	8
13	Dunn et al	1985	Bristol, England	Yes	19.35	X	23 002	13
10	Chaitow and Lillystone	1984	Sydney, Australia	Yes	6.67	X	450	13
19	Heikkilä et al	1984	Helsinki, Finland	Yes	6.06	•	151 924	10
7	Bertol et al	1982	Edinburgh, Scotland	Yes	6.03	X	44 953	13
34	Manning et al	1982	Dublin, Ireland	Yes	12.84	X	39 320	11
14	Dunn and O'Riordan	1981	London, England	Yes	17.77	•	17 562	11
12	Doig and Shannon	1975	Christchurch, New Zealand	Yes	6.01	•	5158	8
33	Bjerkedal and Bakketeig	1975	Bergen, Norway	Yes	11.24	•	6137	7
36	Tibrewala and Pai	1974	Bombay, India	Yes	0.16	X	12 360	11
27	Tanabe et al	1972	Okayama, Japan	Yes	2.13	X	4693	5
20	Hiertonn and James	1968	Uppsala, Sweden	Yes	20.39	X	11 868	10
24	Phillips	1968	Auckland, New Zealand	Yes	3.44	X	43 025	10
15	Finlay et al	1967	Middlesex, England	Yes	4.11	X	14 594	13
28	von Rosen	1962	Malmö, Sweden	Yes	1.67	•	24 000	11
23	Palmén	1961	Falköping, Sweden	Yes	2.15	•	415 542	16
32	Medbö	1961	Alesund, Norway	Yes	9.93	X	3224	10
6	Andren and von Rosen	1958	Malmö, Sweden	Yes	0.91	•	15 373	10
70	Baroncini et al	1997	Lombardy, Italy	No	50.13	•	4648	17
104	Lotito et al	1995	Naples, Italy	No	2.80	X	5000	7
103	Lennox et al	1993	Aberdeen, Scotland	No	49.99	•	67 093	8
94	Bialik et al	1992	Haifa, Israel	No	5.34	•	14 410	10
65	de Pellegrin	1991	Milan, Italy	No	11.09	X	992	15
95	Boo and Rajaram	1989	Kuala Lumpur, Malaysia	No	0.70	X	51 541	9
82	Al-Umran et al	1988	Al-Khobar, Saudi Arabia	No	4.31	X	30 651	10
62	Berman and Klenerman	1986	Toronto, Ontario	No	16.98	X	1001	14
74	MacKenzie and Wilson	1981	Aberdeen, Scotland	No	53.74	•	53 033	14
75	Mendes and Roffman	1980	Haifa, Israel	No	14.58	•	8439	11
76	Monk and Dowd	1980	Liverpool, England	No	60.84	•	25 263	12
77	Noble et al	1978	Newcastle upon Tyne, England	No	10.45	•	25 921	7
92	Beckman et al	1977	Umeå, Sweden	No	7.30	X	40 419	9
80	Fredensborg	1976	Malmö, Sweden	No	9.17	•	58 750	14
115	Ritter	1973	Indianapolis, Indiana	No	9.15	X	3278	15
24	Phillips	1968	Auckland, New Zealand	No	3.44	X	43 025	10
28	von Rosen	1962	Malmö, Sweden	No	1.63	•	24 000	11
111	Walther	1956	Bergen, Norway	No	1.57	•	8260	8

* Three categories means that "clicks" were assessed as an intermediate outcome addressed by the researchers.

† Rate refers to the incidence of a positive examination result.

EVIDENCE TABLE 2. Orthopaedic Newborn Screening

Target Article No.	Author	Year	Location	Three Categories	Positive Rate per 1000	Population • Sample X	Sample (Population) Size	Evidence Quality
41	Deimel et al	1994	Homburg, Germany	Yes	325.42	X	2317	9
17	Gupta et al	1992	New Delhi, India	Yes	18.74	X	6029	11
45	Khan and Benjamin	1992	Abha, Saudi Arabia	Yes	35.23	•	2214	14
46	Krikler and Dwyer	1992	Birmingham, England	Yes	12.48	X	37 511	12
51	Poul et al	1992	Brno, Czech Republic	Yes	18.45	•	35 550	14
39	Burger et al	1990	Leiden, The Netherlands	Yes	9.29	X	15 078	19
48	Macnicol	1990	Edinburgh, Scotland	Yes	3.70	X	13 500	10
54	Tonnis et al	1990	Dortmund, Germany	Yes	44.07	X	2587	15
54	Tonnis et al	1990	Dortmund, Germany	Yes	22.14	X	1310	15
43	Hadlow	1988	New Plymouth, New Zealand	Yes	32.07	•	20 957	13
56	Watanabe and Yanagisawa	1988	Fukushima, Japan	Yes	10.06	X	31 724	10
43	Hadlow	1988	New Plymouth, New Zealand	Yes	1.63	•	202 657	13
38	Bernard et al	1987	West Midlands, England	Yes	9.09	•	21 004	10
52	Rao and Thurston	1986	Wellington, New Zealand	Yes	4.55	X	13 841	13
58	Gross et al	1982	Oklahoma	Yes	3.97	X	10 070	12
55	Tredwell and Bell	1981	Vancouver, Canada	Yes	9.88	X	32 480	14
47	Lehmann and Street	1981	British Columbia	Yes	5.98	•	16 045	4
42	Hadlow	1979	New Plymouth, New Zealand	Yes	15.74	•	10 103	14
44	Jones	1977	Hertfordshire, England	Yes	2.59	•	29 366	12
50	Pompe van Meerdervoort	1976	South Africa	Yes	1.50	X	100 000	8
59	Artz et al	1975	New York, NY	Yes	13.33	X	23 408	14
40	Czeizel et al	1972	Budapest, Hungary	Yes	0.36	•	108 966	9
60	Hirsch and Scheller	1969	Göteborg, Sweden	Yes	7.59	•	12 259	8
53	Smaill	1968	Wellington, New Zealand	Yes	3.83	X	6000	10
23	Palmén	1961	Falköping, Sweden	Yes	5.65	•	12 394	16
57	Yngve and Gross	1990	United States	No	3.82	•	26 455	7
49	Paterson	1976	Adelaide, Australia	No	5.53	•	7409	8

EVIDENCE TABLE 3. Ultrasound Newborn Screening

Target Article No.	Author	Year	Location	Ultrasound Method	Child•* Hip X	Positive Rate per 1000†	Positive + Intermediate Rate per 1000‡	Ultrasound Intermediate Category§	Population • Sample X	Sample (Population) Size	Evidence Quality
70	Baronciani et al	1997	Lombardy, Italy	Graf	•	50.99	50.99		•	4648	17
41	Deimel et al	1994	Homburg, Germany	Graf	X	16.78	62.39		X	6197	9
66	Ganger et al	1992	Vienna, Austria	Graf	•	32.51	32.51		X	1292	15
65	de Pellegrin	1991	Milan, Italy	Graf	X	28.50	28.50		X	2000	15
67	Jones and Powell	1990	Swansea, Wales	Graf	•	103.45	120.00	Graf II	X	406	15
54	Tonnis et al	1990	Dortmund, Germany	Graf	X	26.48	26.48		X	5174	15
71	Exner	1988	Zurich, Switzerland	Graf	•	3.25	3.32		X	615	13
68	Langer	1987	Berlin, Germany	Graf	X	6.51	7.53		X	2917	15
31	Dorn and Hattwich	1987	Salzburg, Austria	Graf	X	14.44	14.44		X	6094	13
62	Berman and Klenerman	1986	Toronto, Ontario	Graf	•	5.00	27.97	Graf II	X	1001	14
69	Marks et al	1994	Coventry, England	Harke	•	224.32	224.32		•	847	11
64	Castelein et al	1992	Rotterdam, The Netherlands	Harke	X	62.23	208.39	50 < a < 60	X	691	14
63	Castelein and Sauter	1988	The Hague, The Netherlands	Harke	•	6.51	186.13	"Abnormal"	X	307	15
11	Clarke	1986	Birmingham, England	Harke	•	17.09	18.18		X	117	17
61	Andersson and Funnemark	1995	Göteborg, Sweden	Other	•	0.90	10.84	"Dislocatable"	•	4430	17
22	Holen et al	1994	Trondheim, Norway	Other	•	12.33	12.71		X	4459	14
25	Rosendahl et al	1994	Bergen, Norway	Other	•	29.62	29.62		•	3613	15

* Unit of analysis in the study.

† Positives only.

‡ Includes intermediates.

§ Blank implies our standard category.

EVIDENCE TABLE 4. Late-Term Cases After Pediatric Newborn Screen

Target Article No.	Author	Year	Location	Who Examined		Rates per 1000			Sample (Population) Size	Evidence Quality
				Newborn	Later	6 to 12 Months of Age	>12 Months of Age	Population Sample X		
25	Rosendahl et al	1996	Bergen, Norway	Unstated	Unstated	0.76	0.51	•	3924	15
4	Bjerkreim et al	1993	Oslo, Norway	Pediatric resident + orthopaedist	Child welfare clinic	1.00		•	140 185	6
79	Sanfridson et al	1991	Malmö, Sweden	Pediatrician	Unstated	0.03	0.06	•	96 891	8
30	Gardiner and Dunn	1990	Bristol, England	Pediatric registrar	HO + Study protocol		0.12	X	16 134	17
1	Clarke et al	1989	Coventry, England	Pediatric registrar	Routine clinical checks		0.77	•	3900	9
72	Hazel and Beals	1989	Portland, OR	Pediatrician	Primary care provider	0.03	0.10	X	39 429	4
38	Bernard et al	1987	West Midlands, England	Physiotherapist	Unstated	0.10	0.05	•	20 814	10
9	Bower et al	1987	Nedlands, Australia	Child health nurse + physician	Child health nurse	0.44	0.04	•	67 689	6
73	Heikkilä	1984	Helsinki, Finland	Pediatrician	Unstated	0.76		•	151 004	5
7	Bertol et al	1982	Edinburgh, Scotland	Pediatrician	Unstated	0.63		X	44 682	13
14	Dunn and O'Riordan	1981	London, England	Pediatric registrar	Unstated		0.67	•	19 356	11
74	MacKenzie and Wilson	1981	Aberdeen, Scotland	Pediatrician + family physician	Unstated	0.62		•	50 177	14
14	Dunn and O'Riordan	1981	London, England	Pediatric registrar	Unstated		0.99	•	17 250	11
75	Mendes and Roffman	1980	Haifa, Israel	Pediatric resident + orthopaedist	Well-baby clinic	0.36		•	8319	11
76	Monk and Dowd	1980	Liverpool, England	Pediatric resident + orthopaedist	Unstated	0.13		•	23 276	12
77	Noble et al	1978	Newcastle upon Tyne, England	Neonatal registrar	Unstated		0.08	•	25 921	7
78	Place et al	1978	Leeds, England	Unstated	Unstated	0.30	0.59	X	26 908	6
81	Bjerkreim and Årseth	1978	Oslo, Norway	Unstated	Child welfare clinic	1.02		•	99 682	14
44	Jones	1977	Hertfordshire, England	Mix	Unstated	0.58		•	29 236	12
80	Fredensborg	1976	Malmö, Sweden	Pediatrician	Parent	0.00	0.05	•	58 211	14
12	Doig and Shannon	1975	Christchurch, New Zealand	Pediatric registrar	Unstated	0.30	0.30	•	23 443	8
27	Tanabe et al	1972	Okayama, Japan	Unstated	Unstated	0.00		•	4693	5
40	Czeizel et al	1972	Budapest, Hungary	Mix	Unstated	3.73	0.59	•	108 966	9
15	Finlay et al	1967	Middlesex, England	Pediatrician	Family physician		0.07	X	14 535	13
23	Palmén	1961	Falköping, Sweden	Obstetrician	Unstated	0.05	0.31	•	839 986	16

* Ortho indicates orthopaedist; HO, house officer.

EVIDENCE TABLE 5. Late-Term Cases After Orthopaedic Newborn Screen

Target Article No.	Author	Year	Location	Who Examined		Rates per 1000			Sample (Population) Size	Evidence Quality
				Newborn	Later	6 to 12 Months of Age	>12 Months of Age	Population • Sample X		
2	Fiddian and Gardiner	1994	Poole, England	Physiotherapist	Unstated	0.02	0.22	•	41 361	13
43	Hadlow	1988	New Plymouth, New Zealand	Orthopaedist	Unstated		0.10	•	20 328	13
47	Lehmann and Street	1981	British Columbia	Resident or attending physician	Unstated	0.09		•	23 223	4
55	Tredwell and Bell	1981	Vancouver, British Columbia	Orthopaedist	Unstated	0.19		X	32 165	14

EVIDENCE TABLE 6. Late-Term Cases After Ultrasound Newborn Screen

Target Article No.	Author	Year	Location	Who Examined		Rates per 1000			Sample (Population) Size	Evidence Quality
				Newborn	Later	6 to 12 Months of Age	>12 Months of Age	Population • Sample X		
25	Rosendahl et al	1994	Bergen, Norway	Unstated	Unstated	0.28		•	3613	15
25	Rosendahl et al	1994	Bergen, Norway	Unstated*	Unstated	0.46	0.23	•	4388	15

* These patients have risk factors for developmental dysplasia of the hip.

EVIDENCE TABLE 7. AVN After Early* Detection of DDH

Target Article No.	Author	Year	Location	Initial Orthopaedic Referral	AVN Rate per 1000	Population • Sample X	Sample (Population) Size	Evidence Quality
86	Teanby and Paton	1997	Blackburn, England	•	0.00	X	22	6
83	Kruczynski	1996	Poznan, Poland	•	80.81	X	99	13
87	Sochart and Paton	1996	Manchester, England	X	0.00	X	65	7
2	Fiddian and Gardiner	1994	Poole, England	•	0.00	•	255	13
35	Fiddian and Gardiner	1993	Poole, England	•	0.00	•	255	7
51	Poul et al	1992	Brno, Czech Republic	•	1.52	•	656	14
85	Szulc	1991	Warsaw, Poland	•	0.00	•	160	4
82	Al-Umran et al	1988	Al-Khobar, Saudi Arabia	•	0.00	X	99	10
43	Hadlow	1988	New Plymouth, New Zealand	•	3.02	•	331	13
84	Pool et al	1986	Adelaide, Australia	X	123.22	X	211	8
13	Dunn et al	1985	Bristol, England	•	0.00	X	445	13
58	Gross et al	1982	Oklahoma	•	0.00	X	40	12
42	Hadlow	1979	New Plymouth, New Zealand	•	6.29		159	14
77	Noble et al	1978	Newcastle upon Tyne, England	•	22.14	•	271	7
37	Fredensborg and Nilsson	1976	Malmö, Sweden	•	1.82	•	548	7
60	Hirsch and Scheller	1969	Göteborg, Sweden	•	43.01	•	93	8

* Before 2 months of age.

EVIDENCE TABLE 8. AVN After Later Detection of DDH*

Target Article No.	Author	Year	Location	Initial Orthopaedic Referral	AVN Rate per 1000	Population • Sample X	Sample (Population) Size	Evidence Quality
83	Kruczynski	1996	Poznan, Poland	4–12 mo	162.63	X	289	13
83	Kruczynski	1996	Poznan, Poland	>12 mo	215.69	X	51	13
83	Kruczynski	1996	Poznan, Poland	>2 wk	142.86	X	693	13
88	Burgos et al	1995	Madrid, Spain	>4 mo	96.15	X	104	17
85	Szulc	1991	Warsaw, Poland	>2 wk	107.67	•	1226	4
89	Suzuki and Yamamuro	1990	Kyoto, Japan	2 wk–12 mo	163.64	X	220	15
90	Theodorou and Gerostathopoulos	1989	Athens, Greece	2 mo–12 mo	12.67	X	947	0
19	Heikkilä et al	1984	Helsinki, Finland	Newborn to 12 mo	27.05	•	1035	10

* After 2 months of age.

EVIDENCE TABLE 9. Risk of DDH in Girls: Pediatric Screen

Target Article No.	Author	Year	Location	Odds Ratio wrt* Nonbreach	Sample (Population) Size	Evidence Quality
22	Holen et al	1994	Norway	6.26	4458	14
95	Boo and Rajaram	1989	Malaysia	2.41	52 379	9
9	Bower et al	1987	Australia	3.85	67 970	6
19	Heikkilä et al	1984	Finland	10.65	147 820	10
34	Manning et al	1982	Ireland	3.10	39 320	11
75	Mendes and Roffman	1980	Israel	3.34	8439	11
77	Noble et al	1978	United Kingdom	6.54	25 890	7
97	Cyvin	1977	Norway	3.33	19 864	10
115	Ritter	1973	United States	3.52	3278	15
24	Phillips	1968	New Zealand	2.81	43 025	10
15	Finlay et al	1967	England	3.86	14 593	13

* wrt indicates with respect to (comparison).

EVIDENCE TABLE 10. Risk of DDH in Girls: Orthopaedic Screen

Target Article No.	Author	Year	Location	Odds Ratio wrt* Nonbreach	Sample (Population) Size	Evidence Quality
55	Tredwell and Bell	1981	Canada	4.26	32 480	14
49	Paterson	1976	Australia	3.31	7409	8
59	Artz et al	1975	United States	4.16	23 720	14
60	Hirsch and Scheller	1969	Sweden	7.12	12 320	8

* wrt indicates with respect to (comparison).

EVIDENCE TABLE 11. Risk of DDH in Girls: Ultrasound Screen

Target Article No.	Author	Year	Location	Odds Ratio wrt* Nonbreach	Sample (Population) Size	Evidence Quality
70	Baroncini et al	1997	Italy	3.79	4648	17
70	Baroncini et al	1997	Italy	7.53	2648	17
68	Langer	1987	Germany	6.19	2920	15

* wrt indicates with respect to (comparison).

EVIDENCE TABLE 12. Risk of DDH in Breech Position: Pediatric Screen

Target Article No.	Author	Year	Location	Odds Ratio wrt* Nonbreech	Sample (Population) Size	Evidence Quality
22	Holen et al	1994	Norway	4.77	4449	14
17	Gupta et al	1992	India	3.72	6036	11
65	de Pellegrin	1991	Italy	0.59	2000	15
95	Boo and Rajaram	1989	Malaysia	27.94	52 379	9
13	Dunn et al	1985	England	11.23	23 002	13
34	Manning et al	1982	Ireland	3.92	39 320	11
77	Noble et al	1978	United Kingdom	3.33	26 921	7
97	Cyvin	1977	Norway	11.63	756	10
115	Ritter	1973	United States	0.00	3278	15
24	Phillips	1968	New Zealand	6.04	43 024	10

* wrt indicates with respect to (comparison).

EVIDENCE TABLE 13. Risk of DDH in Breech Position: Orthopaedic Screen

Target Article No.	Author	Year	Location	Odds Ratio wrt* Nonbreech	Sample (Population) Size	Evidence Quality
39	Burger et al	1990	The Netherlands	3.78	14 264	19
39	Burger et al	1990	The Netherlands	12.54	14 264	19
55	Tredwell and Bell	1981	Canada	4.74	32 500	14
49	Paterson	1976	Australia	8.10	7409	8
12	Doig and Shannon	1975	New Zealand	16.66	7361	8
59	Artz et al	1975	United States	6.38	23 072	14
15	Finlay et al	1967	England	6.76	14 594	13

* wrt indicates with respect to (comparison).

EVIDENCE TABLE 14. Risk of DDH in Breech Position: Ultrasound Screen

Target Article No.	Author	Year	Location	Odds Ratio wrt* Nonbreech	Sample (Population) Size	Evidence Quality
65	de Pellegrin	1991	Italy	0.59	2000	15

* wrt indicates with respect to (comparison).

EVIDENCE TABLE 15. Risk of DDH With Positive Family History: Pediatric Screen

Target Article No.	Author	Year	Location	Odds Ratio wrt* Nonbreech	Sample (Population) Size	Evidence Quality
22	Holen et al	1994	Norway	2.50	4459	14
65	de Pellegrin	1991	Italy	2.02	1995	15
13	Dunn et al	1985	England	2.50	23 002	13
97	Cyvin	1977	Norway	11.58	708	10

* wrt indicates with respect to (comparison).

EVIDENCE TABLE 16. Risk of DDH With Positive Family History: Ultrasound Screen

Target Article No.	Author	Year	Location	Odds Ratio wrt* Nonbreech	Sample (Population) Size	Evidence Quality
70	Baroncini et al	1997	Italy	3.53	4648	17
65	de Pellegrin	1991	Italy	2.02	2000	15

* wrt indicates with respect to (comparison).

Developmental Dysplasia of the Hip Practice Guideline: Technical Report
Harold P. Lehmann, Richard Hinton, Paola Morello, Jeanne Santoli and in conjunction
with the Committee on Quality Improvement Subcommittee on Developmental
Dysplasia of the Hip
Pediatrics 2000;105:e57
DOI: 10.1542/peds.105.4.e57

Updated Information & Services

including high resolution figures, can be found at:
<http://pediatrics.aappublications.org/content/105/4/e57>

References

This article cites 120 articles, 8 of which you can access for free at:
<http://pediatrics.aappublications.org/content/105/4/e57#BIBL>

Subspecialty Collections

This article, along with others on similar topics, appears in the following collection(s):

Current Policy

http://www.aappublications.org/cgi/collection/current_policy

Council on Quality Improvement and Patient Safety

http://www.aappublications.org/cgi/collection/council_on_quality_improvement_and_patient_safety

Steering Committee on Quality Improvement and Management

http://www.aappublications.org/cgi/collection/steering_committee_on_quality_improvement_and_management

Administration/Practice Management

http://www.aappublications.org/cgi/collection/administration:practice_management_sub

Practice-Based Learning & Development

http://www.aappublications.org/cgi/collection/practice-based_learning_-_development_sub

For Your Benefit

http://www.aappublications.org/cgi/collection/for_your_benefit

Fetus/Newborn Infant

http://www.aappublications.org/cgi/collection/fetus:newborn_infant_sub

Permissions & Licensing

Information about reproducing this article in parts (figures, tables) or in its entirety can be found online at:

<http://www.aappublications.org/site/misc/Permissions.xhtml>

Reprints

Information about ordering reprints can be found online:

<http://www.aappublications.org/site/misc/reprints.xhtml>

American Academy of Pediatrics

DEDICATED TO THE HEALTH OF ALL CHILDREN™



PEDIATRICS®

OFFICIAL JOURNAL OF THE AMERICAN ACADEMY OF PEDIATRICS

Developmental Dysplasia of the Hip Practice Guideline: Technical Report
Harold P. Lehmann, Richard Hinton, Paola Morello, Jeanne Santoli and in conjunction
with the Committee on Quality Improvement Subcommittee on Developmental
Dysplasia of the Hip
Pediatrics 2000;105:e57
DOI: 10.1542/peds.105.4.e57

The online version of this article, along with updated information and services, is
located on the World Wide Web at:

<http://pediatrics.aappublications.org/content/105/4/e57>

Pediatrics is the official journal of the American Academy of Pediatrics. A monthly publication, it has been published continuously since 1948. Pediatrics is owned, published, and trademarked by the American Academy of Pediatrics, 141 Northwest Point Boulevard, Elk Grove Village, Illinois, 60007. Copyright © 2000 by the American Academy of Pediatrics. All rights reserved. Print ISSN: 1073-0397.

American Academy of Pediatrics

DEDICATED TO THE HEALTH OF ALL CHILDREN™

